

United States
Department of
Agriculture

Forest Service

**Northeastern
Area**
State and
Private Forestry

NA-TP-06-98

Radnor PA
July 1998

A Landowner's Guide to Building Forest Access Roads



Richard L. Wiest

Table of Contents

Introduction

Road Planning and Location

- Know the Land
- Map Out the Road Location
- Field Check the Road Location
- Control Points
- Curves
 - Horizontal Curve Layout
 - Center Stake Method
 - Stick Method
- Adjusting for Topography and Grade
- Switchbacks
- Grade Separation and Vertical Curves
- Points to Remember
- Other Considerations
 - Turnouts and Turnarounds
 - Road Cross-Sections
 - Right-of-Way Agreements

Stream Crossing Methods

- Pipe Culverts
 - Sizing
 - Installation
 - Maintenance
- Fords

Protecting Fish Habitat

- Round Culvert
- Pipe-Arch Culvert
- Structural Plate-Arch Culvert
 - Culvert Outfall Barriers
 - Structures for Debris Control

Recommendations for Wetland Forest Roads

- General Planning and Design
- Construction
 - Crossing Mineral Soil Wetlands
 - Crossing Shallow Peat Wetlands
 - Crossing Deep Peat Wetlands

Road Construction

- Road Width
- Clearing
- Road Drainage Methods
 - Water Bars
 - Broad-Based Drainage Dips
 - Ditches
 - Outsloping
 - Deflectors
 - Open Top and Pole Culverts
- Shaping Back Slopes
- Seeding and Mulching
 - Seeding
 - Mulching

Road Maintenance and Closure

- Road Maintenance
 - Clearing Culverts and Ditches
 - Removing Slide Debris
- Road Closure
 - Temporary Roads
 - Permanent Seasonal Roads

- Methods for Crossing Wetlands Using Geotextiles
- Log Corduroy
- Rock Drainage Layer
- Lightweight Road Fill
- Crossing Wetlands in Winter

Dealing With Beavers

Geotextiles

- Separation
- Filtration
- Reinforcement
- Transmission

References

Glossary

Conversion Chart

Introduction

Roads provide needed access to small woodlots; however, high costs, land disturbance, degradation of water quality, and destruction of fish habitat can all result from poor development, construction, and maintenance of forest roads. This guide was developed to give private owners of small woodlots the basic information needed to avoid these problems and protect valued natural resources.

This guide is designed for landowners in the northeastern United States who will use a tractor and ordinary earth moving equipment to build the simplest access roads on their property, or who will contract for these services. Logging roads on small woodland properties are usually constructed by the logging contractor, sawmill operator, or by a road contractor.

This guide applies to low-speed forest roads with a 12-foot-wide running surface that are needed only temporarily or only during certain times of the year. Recommendations in this guide cover basic planning, construction, drainage, maintenance, and closure of such forest roads. The recommendations incorporate best management practices, which are designed to reduce nonpoint-source pollution, as can occur during road building.

This guide also covers special situations involving water that require individual consideration: streams with or without migratory fish, beaver ponds, and wetlands. Each of these situations is covered in a separate section. Landowners should read each section that applies to their land.

Geotextiles are also described in a separate section. These synthetic permeable materials can be used during road building in a variety of ways, from providing standard drainage to performing specialized functions in wetlands. Using the information in this guide, landowners can complete road building projects to their satisfaction. They can also save on the cost of construction and future maintenance by understanding what is involved and by being able to provide information to a contractor.

Sections of this guide were adapted from other sources:

Road Planning and Location, from Darrach et al. (1981) and Haussman and Pruett (1978);

Protecting Fish Habitat, from Furniss et al. (1991);

Recommendations for Wetland Forest Roads, from Minnesota Department of Natural Resources (1995);

Dealing With Beaver, from Buech (1985), D'Eon et al. (1995), Wood and Woodward (1992), and Wood et al. (1994); and

Geotextiles, from Amoco Fabrics and Fibers Company (1994a,b).

Return to [A Landowner's Guide to Building Forest Access Roads Table of Contents](#)

Road Planning and Location

Planning and location are the most important aspects of road development. Poor planning or location is associated with the following most common causes of road failure (Furniss et al. 1991):

Improper placement and construction of road fills

Insufficient culvert sizes

Very steep road grades

Improper placement or sidecast of excess materials

Removal of slope support by undercutting

Altering drainage by interception and concentrating surface and subsurface flows.

Because roads are long-term features, their location must be carefully chosen, to meet the landowner's need for safe access, avoid long-term maintenance problems, reduce potential for degrading water quality, and minimize costs over the short and long term. At a minimum, road locations should be flagged and approved by the landowner in advance of any construction, including all temporary road locations.



Poor road location can concentrate runoff, which results in increased sedimentation, and can have long lasting effects and create long-term road maintenance problems (Furniss et al. 1991).



This section on road planning and location tells you how to map out a road, then how to field check the location and how to mark it on the ground.

Know the Land

The key to good road planning is to gather as much information as possible on the area to which access is needed. If subcontracting for road building, this recommendation still applies. The subcontractor generally will not know the area as well as you do. In most cases, maps and soils information are available. Contour maps are useful on all but the flattest terrain and can usually be obtained from local, county, or State governments. They are also available from the U.S. Geological Survey. The USDA Natural Resources Conservation Service (NRCS) will be able to provide soils information for your area.

When initially requesting maps, also request information from the State or county about rights-of-way requirements if the proposed road has the potential of entering onto a State or county road. The necessary right-of-way requirements can be met as you proceed in the planning process.

Map Out the Road Location

After gathering the maps and related information, indicate control points on the maps. A control point is simply a land feature that limits your choice of road location. Control points can force a road through a given location or prevent the road from being built in a given location. The following is a list of control points with some general comments about each one. The list is not all-inclusive and is not intended to be.

Rock outcrops—Cross above or below these. If you have to go through them, see if the rock can be ripped or broken because this will be less costly than blasting.

Ridges—These provide good road locations.

Saddles—Look for these as points to cross ridges.

Benches—These are good road locations and also provide a good point for location of junctions, switchbacks, and landings.

Wet meadows—Avoid. If they have to be crossed, see the section on Recommendations for Wetland Forest Roads.

Sinkholes—Avoid.

Beginning and ending of road—Usually known.

Property lines—Be sure of property line locations.

Streams—Avoid crossing streams, if practical. If unavoidable, look for the best places to cross, considering the following (Furniss et al. 1991):

- Always cross at right angles.
- Cross at points where the stream is narrow.
- Minimize the number of crossings.
- Do not build in the bottom of a draw.
- Leave a buffer zone of undisturbed ground between the road and streambed, where the road runs parallel to the stream.

Table 1 gives recommended buffer widths for Minnesota, which are consistent with the recommendations of Haussman and Pruett (1978) for the northeastern United States. Since recommended buffer widths vary, check the regulations in your State.

Approaches to public roads and highways, power lines, or other easements—State, Federal, and county regulations require permits to enter public roadways. Locations of approaches may be restricted for safety or other reasons. Road access easements need to be checked and approved before you proceed any further.

Table 1. Recommended buffer widths

Slope of the land between road and stream (percent)	Recommended buffer width in feet (slope distance*)
0 - 10	50
11 - 20	51 - 70
21 - 40	71 - 110
41 - 70	111 - 150

*For roads, slope distance is measured from the edge of soil disturbance. For fills, slope distance is measured from the bottom of the fill slope.

Other items to consider, which are too broad to be called control points, are aspect and soils.

Aspect—South- and west-facing slopes will usually be drier and free of snow sooner in spring. This may be a minor consideration in your area depending on soils, precipitation, and topography.

Soils—Check the local soil survey to determine the types of soil in your area. Determine which soil characteristics react to road building and how. The county engineer or NRCS engineer can answer questions on soils in your area. Certain plants give an indication of problem soils. Contact your State agronomist for information on indicator plants for problem soils. NRCS may also have information available on plant identification.

As these control points are found, locate them on a contour map and label them. You may not find all the control points in the initial investigation, so you should update your map as you progress through the planning process.

Using the contour map, pencil in a tentative road location using your beginning and ending points as a start. Draw the road in the desired location that accesses the desired area making sure control points are either hit or missed. Remember, control points can be points where the road should go or places to avoid (Figure 1).

Once you have mapped a tentative road location determine the grade of the road. See Figure 1, for example. This will give you a rough idea of how steep the road will be and will point out sections of road where the grade may be too steep. If the grade is too steep, move the road until a satisfactory grade is obtained. Look for any additional control points you were not aware of and add them to the maps. Determine the

grade for each road segment between control points, using either topographic maps or the following formula for determining average grade for the entire road.

$$\frac{\text{Elevation difference between segments of road}}{\text{Length of road}} = \text{grade} \times 100 \% \text{ grade}$$

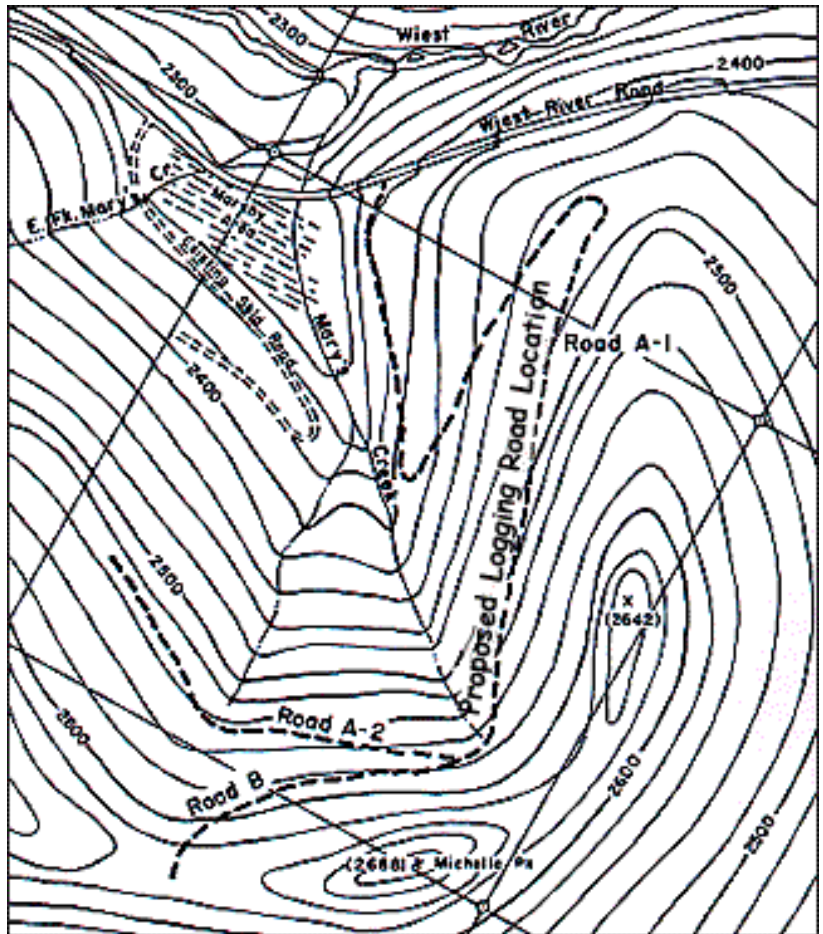

Figure 1. Map out the road by locating and labeling control points on a contour map, which allows you to check the road grade.

Grade problems will be evident at this point. If a segment shows a grade greater than 12 percent for over 300 feet, consider another road location. Under good conditions, the road grade would be less than 8 percent. When necessary, however, short steep pitches under 300 feet in length are acceptable.

<u>Road Information</u>	<u>A-1</u>	<u>A-2</u>	<u>B</u>
Elevation at beginning (feet)	2,365	2,575	2,575
Elevation at end (feet)	2,575	2,530	2,630
Rise (feet)	210	-45	55
Length (feet)	10,500	4,600	3,300
Grade (percent)	2.0	-1.0	1.7

Field Check the Road Location

Control Points

Begin field checking the road location after it is mapped, by locating on the ground all the control points indicated on the map. This field check involves tying ribbon along the proposed location. The ribbon location is called the tagline, which is located on the approximate grade as drawn on the map. An abney or clinometer that shows percent grade will be needed to transfer the mapped road to the ground. If these other tools are not available, the grade meter at the back of this guide can be used (West Virginia Dep. Agric., no date).

To locate your tagline use a clinometer or abney and tie ribbons at eye level. Move ahead towards the next control point and look back to the previous ribbon, then tie another ribbon at eye level or at the height of the instrument being used. Distance can be determined from the map.

Curves

Two types of curves are commonly found in roads: horizontal and vertical curves. A horizontal curve is needed where the road changes direction. If the direction change is dramatic, the curve will need to be large enough to allow a log truck to negotiate the turn. A vertical curve is created where the grade changes from downhill to uphill or uphill to downhill. Planning vertical curves is also important because they can be made so abrupt that a log truck could high center at a crest. Some simple methods for laying out curves follow. Certain circumstances require switchbacks, which are also described in detail.

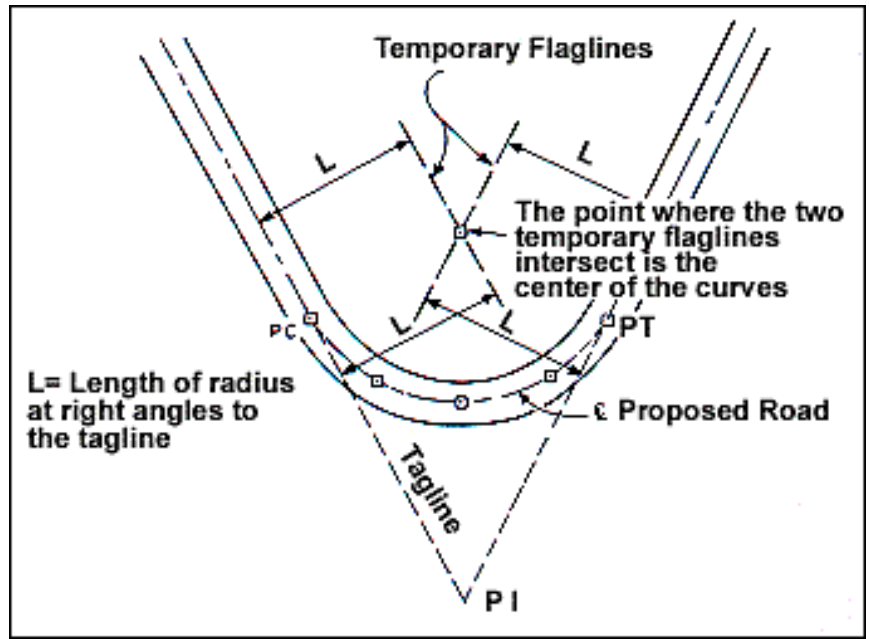

Figure 2. The center stake method of creating a horizontal curve is limited to use on gentle terrain with good visibility. (Redrawn from Figure 2.4-1, Darrach et al. 1981)

Horizontal Curve Layout

Two simple procedures are described for creating a horizontal curve. The first is the center stake method; the second is the stick method. The center stake method is limited to gentle terrain and good visibility. The stick method is more suited to difficult sites.

A curve should always meet the minimum turning requirements of the vehicles expected to use the road. Log trucks require a minimum of a 50-foot radius curve. Flatbed trucks used to haul heavy equipment (lowboys) must have at least a 70-foot radius curve. Grade should be adjusted through the curve to provide for safe handling of heavy equipment. See Table 2 for grade adjustments.

Center stake method

Using a string or tape the length of the radius, find the center of the curve by trial and error (Figure 2). Do this by moving back and forth along the straight road segments (tangents) leading into and out of the curve with the tape at a right angle to the road until a common point, the center, is found. Now scribe an arc along the ground marking the curve. Place stakes at suitable intervals to mark the curve starting at the point of curvature (PC) and ending at the point of tangency (PT)

Table 2. Suggested reductions in grade by curve radius

Radius (feet)	Reduction in grade (percent)
150 to 460	1
90 to 150	2
65 to 90	3
50 to 65	4

Source: Table 2.4-1, Darrach et al. 1981

Curve Layout – Stick Method

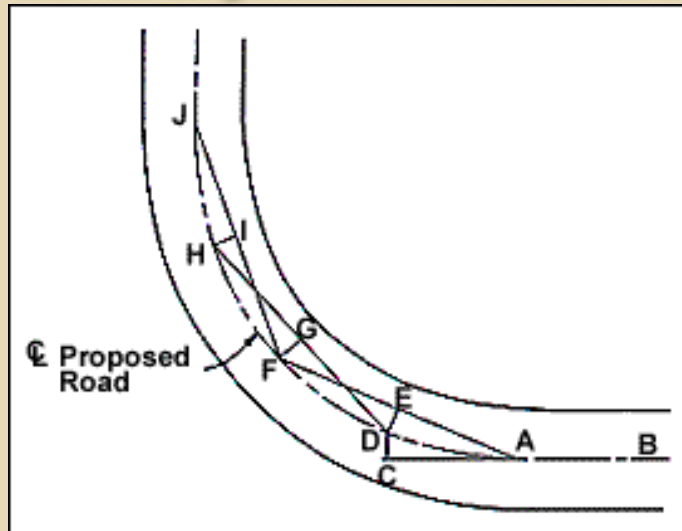

Figure 3. The stick method of creating a horizontal curve is suited to use on difficult terrain. (Redrawn from Figure 2.4-2, Darrach et al. 1981)

Curve Layout—Stick Method

(Refer to Figure 3)

1. Using Table 3, select a suitable staking distance and matching stick length for the desired radius curve. Mark your stick to the correct length.
2. Set stake A at the beginning of the curve and extend line BA the chosen staking distance (either 25 ft or 50 ft) to temporary stake C.
3. Using your marked stick, set stake D at a right angle to line AC. Stake D is a point on the curve.
4. Set stake E so that line AE equals the staking distance, and line ED is at a right angle to AE and ED is the stick length.
5. Extend line AE the staking distance from stake E. Set stake F. Stake F is a point on the curve.
6. Return to stake D and repeat steps 4 and 5. Continue returning each time to the previous point on the curve until the curve is complete.

Table 3. Stick length

Curve radius (feet)	Stake distance	
	25 feet	50 feet
	feet	
50	6.7*	
60	5.5	26.8
80	4.1	17.6
100	3.2	13.4
150	2.1	8.6
200	1.6	6.4
250	1.3	5.1
300	1.1	4.2
350	0.9	3.6
400	0.8	3.1
600	0.5	2.1
800	0.4	1.6
1,000	.03	1.3

Source: Table 2.4-2, Darrach et al. 1981

*To convert tenths of feet to inches, multiply the decimal fraction by 12; for example, 0.7 feet \times 12=8.4 inches.

Constructing a Switchback

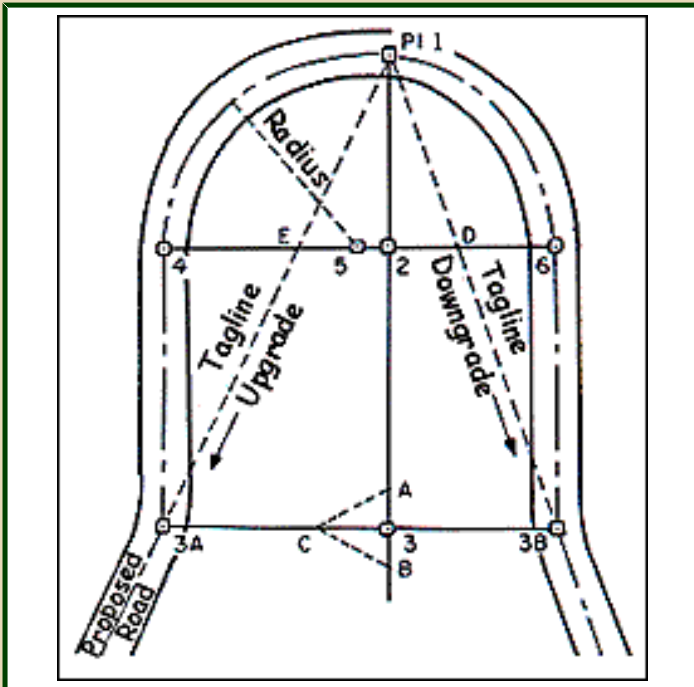

Figure 4. A switchback is needed when a straight road would exceed maximum acceptable grade. (Redrawn and adapted from Figure 2.4-3, Darrach et al. 1981)

Bisecting an angle

1. Place stake 1 at intersection point.
2. Measure equal distances along taglines from stake 1 and set stakes D and E.
3. Halfway between stakes D and E along a straight line, place stake 2.
4. The line between stakes 1 and 2 bisects the angle.

Constructing a right angle

1. Set stake 3.
2. Set stakes A and B equal distances from stake 3.
3. Set stake C so that lines AC, BC, and AB are equal length.
4. Line 3, 3A is at right angles to line 2-3.

Constructing a Switchback

(Refer to Figure 4)

1. Stake the point of intersection (PI) of the two grade lines, stake 1.
2. Bisect the intersection angle (see directions above) and set stake 2 on the line, the distance of a curve radius from (PI) along the line that bisects the angle.
3. Place stake 3 where a right angle line equal to curve diameter just touches the two grade lines. Set stakes 3A and 3B.
4. From the upper tagline, run a new grade line back to the curve from stake 3A at approximately 2 percent less than the tagline grade. Where this new line reaches the extension of the right angle line from stake 2, set a new stake 4.
5. Measure the radius distance along the right angle line from stake 4 and place a stake 5 for the new center of the curve.
6. Mark out a curve using the center stake 5 until the extended right angle line from stake 2 is again reached. Set stake 6.

7. From stake 6, run a grade line that will reach stake 3B along the lower side of the curve.
8. Note: distances measured are horizontal (correct for slope using Table 4). Construct a right angle (see directions above).

Stick method

Simple curves may be staked on the ground with a stick and a tape. For directions see the box on Curve Layout—Stick Method. Using a 25- or 50-foot staking distance, consult Table 3 for the proper stick length to set the radius shown. Figure 3 shows the process.

Table 4. Slope corrections in feet per foot for percent slopes*

Slope (percent)	Correction for 1 foot slope length
10	1.00
15	1.01
20	1.02
25	1.03
30	1.04
35	1.06
40	1.08
45	1.10
50	1.12
55	1.14
60	1.17
65	1.19
70	1.22
75	1.25
80	1.28
85	1.31
90	1.35
95	1.38
100	1.41
105	1.45

Source: Table 2.4-3, Darrach et al. 1981

*To find the corrected distance in feet, multiply the measured slope length by the appropriate correction.

Adjusting for Topography and Grade

The horizontal curve layout description assumes the area is flat. Seldom is this the case. Measurements of length must then be adjusted to compensate for slopes.

Where the distance being measured is short, the tape can be held level for one measurement of the entire distance. Where the distance is longer than convenient for this leveling method, measure the distance in segments. Adjust the measured slope length by using Table 4.

Grade may be maintained around the curve by running a line with the desired slope for the distance of the curve. This line will often be away from the center line of the road due to the topography (Figure 3).

Switchbacks

Where two control points cannot be connected by a road with maximum grade in a single direction, a switchback is required. It is placed at the point where there is enough room to make a switchback. Good switchback sites are areas with little side slope where the loop may be constructed with the least excavation. There should be no more excavation of the hillside above the switchback than is needed to fill along the lower side of the switchback.

Reduce the grade of the road coming into and out of the switchback, to help maintain a gentler grade through the curve. The curve itself should not exceed an 8 percent grade. For instructions see Figure 4 and the box on Constructing a Switchback.

Grade Separation and Vertical Curves

Care must be taken not to create a spur that branches off a road too abruptly leaving little room for the grades to separate. Both the main road and spur must have the same grade for a distance equal to at least the sum of half the width of each (Figure 5). For example, a 10-foot-wide spur and a 12-foot-wide road should both have the same grade for a distance of 11 feet.

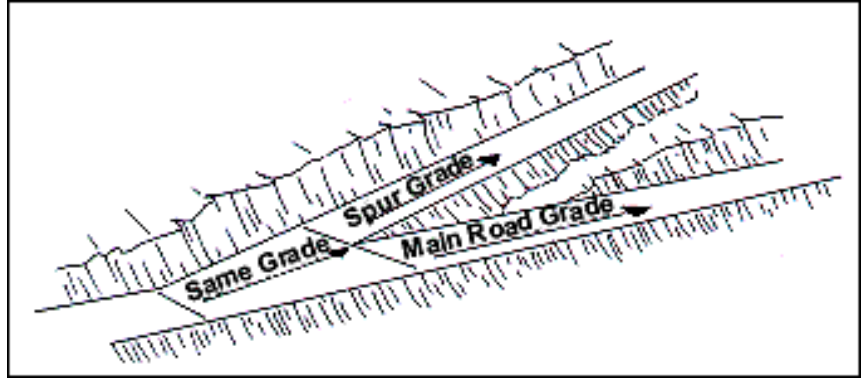

Figure 5. A main road and spur must have the same grade for a distance equal to at least the sum of half the width of each. (Redrawn and adapted from Figure 2.4-7, Darrach et al. 1981)

Vertical curves may either crest or sag. To provide a smooth transition, adjust or offset the height of the road at the point where the uphill and downhill slopes meet. A transition of 200 horizontal feet is sufficient for a simple access road. A vertical offset involves cutting a crest or filling a sag (Figure 6). Table 5 provides additional solutions for 200-foot curves.

Table 5. Vertical offset in feet between the grade intersection point and road surface for 200-foot vertical curves

Grade A %	Grade B%								
	2	4	6	8	10	12	14	16	18
	feet								
2	1.0								
4	1.5	2.0							
6	2.0	2.5	3.0						
8	2.5	3.0	3.5	4.0					
10	3.0	3.5	4.0	4.5	5.0				
12	3.5	4.0	4.5	5.0	5.5	6.0			
14	4.0	4.5	5.0	5.5	6.0	6.5	7.0		
16	4.5	5.0	5.5	6.0	6.5	7.0	7.5	8.0	
18		5.5	6.0	6.5	7.0	7.5	8.0	8.5	9.0

Source: Table 2.4-4, Darrach et al. 1981

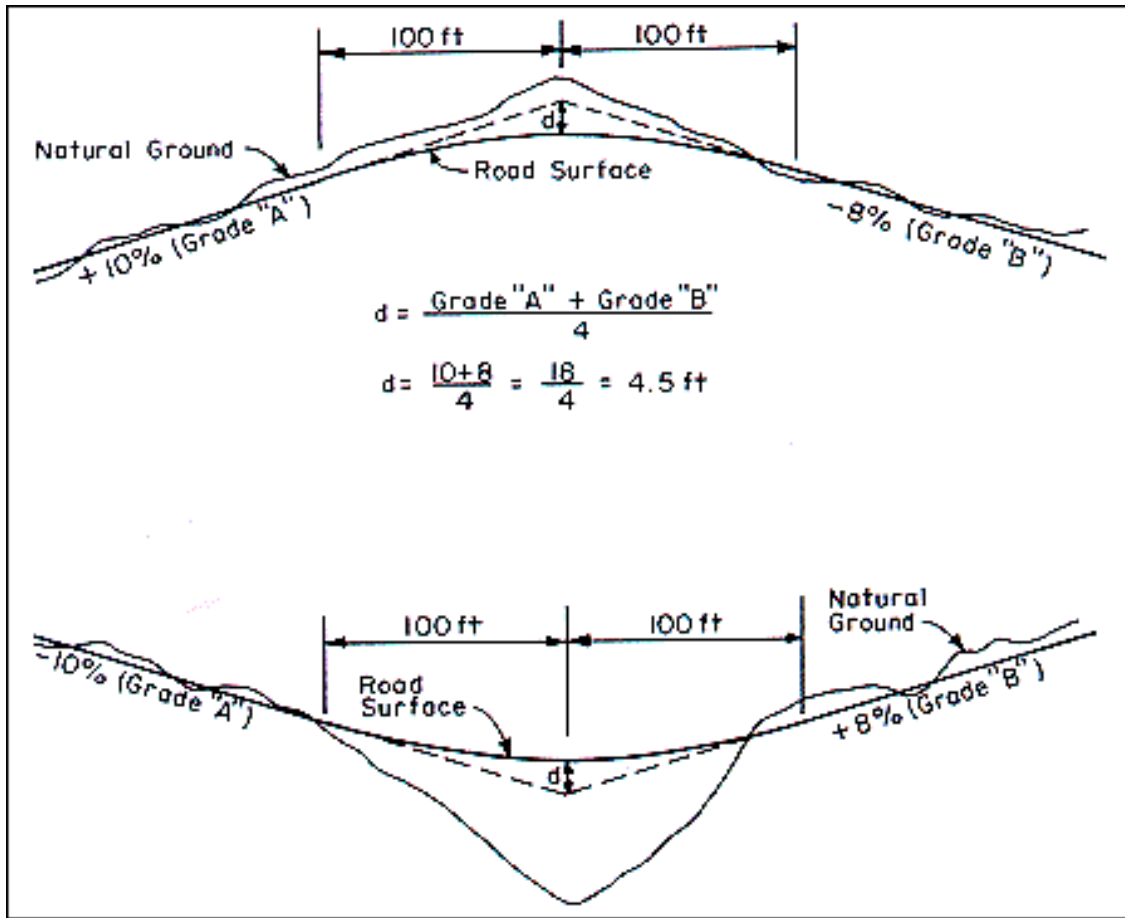

Figure 6. A vertical cut provides a smooth transition on a crest (top), and a vertical fill provides a smooth transition on a sag (bottom). (Redrawn from Figures 2.4-8 and 2.4-9, Darrach et al. 1981)

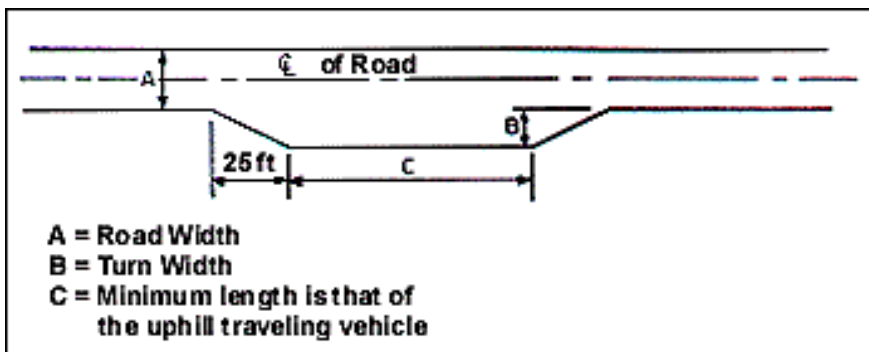

Figure 7. A turnout should be at least 10 feet wide, to allow two trucks to pass safely. (Redrawn from Figure 2.4-10, Darrach et al. 1981)

Points to Remember

1. Make grades constant through curves.
2. Always allow enough fill in a draw to cover a culvert pipe with soil to a depth equal to at least half its diameter in feet, but never less than 1 foot.
3. Reduce grade by 2 percent at least 100 feet before a major grade change in a road that will require heavy trucks to shift gears.
4. When calculating cut and fill depths on vertical curves (Figure 6), be sure to account for the difference between height of the instrument and of the grade line.

Other Considerations

Turnouts and Turnarounds

A turnout is needed when more than one vehicle will use the road at the same time. A turnaround provides a convenient, safe area to turn vehicles at the terminus of a dead end road.

For low speed, single lane roadways, turnouts are usually set within sight of each other. A standard plan for a turnout is shown in Figure 7. Turnout width is set with enough room to allow two trucks to pass safely. The width is never less than 10 feet. Leads into and out of turnouts are typically a minimum of 25 feet long.

Turnarounds are usually located within sight of the road's end on fill. Common dimensions of a turnaround are shown in Figure 8.

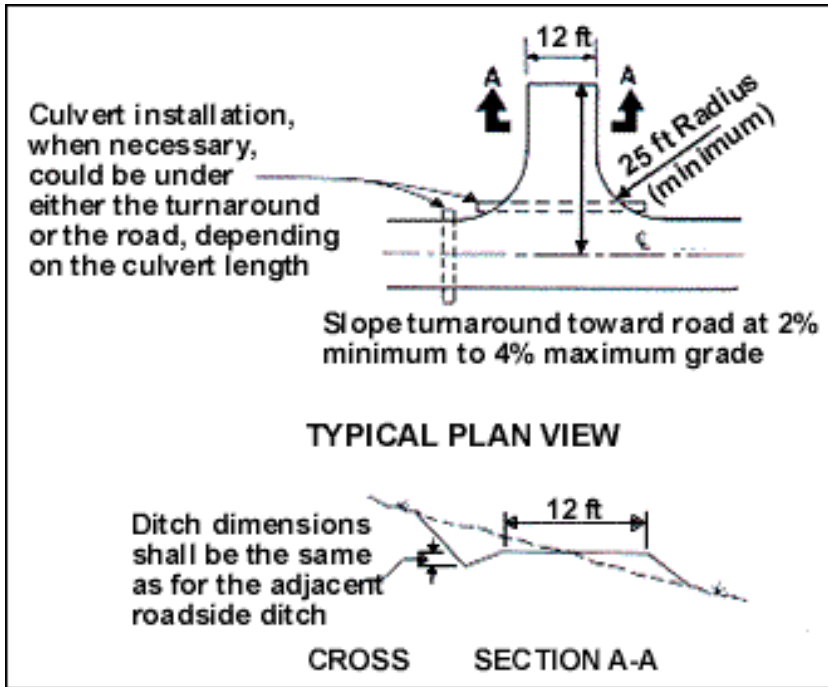

Figure 8. Turnaround design should consider drainage.

Road Cross-Sections

Five road cross-sections typically are used in road construction: crowned fill, crowned turnpike, outslope, inslope with ditch, and crowned and ditched (Figure 9). The choice of which cross-section to use depends on the drainage needed, soil stability, slope, and the expected volume of traffic on the road. You can use these cross-sections in combination as the terrain changes or as drainage problems are encountered.

Crowned fill section is for use on flat ground where water standing on a road surface may be a problem. Outslope section is for use on moderate slopes for low volume roads and stable soils. Outsloping is not recommended on roads requiring winter logging. Inslope with ditch section is for use on steep hills, areas with fine textured soils, winter logging, and areas where drainage is necessary. Crowned and ditched section is for high volume roads on steep side hills.

Right-of-Way Agreements

Where roads cross lands of other owners, permission to cross must be obtained. It is always advisable to obtain written agreements or to record easements. Written agreements and recorded easements protect the interests of all parties.

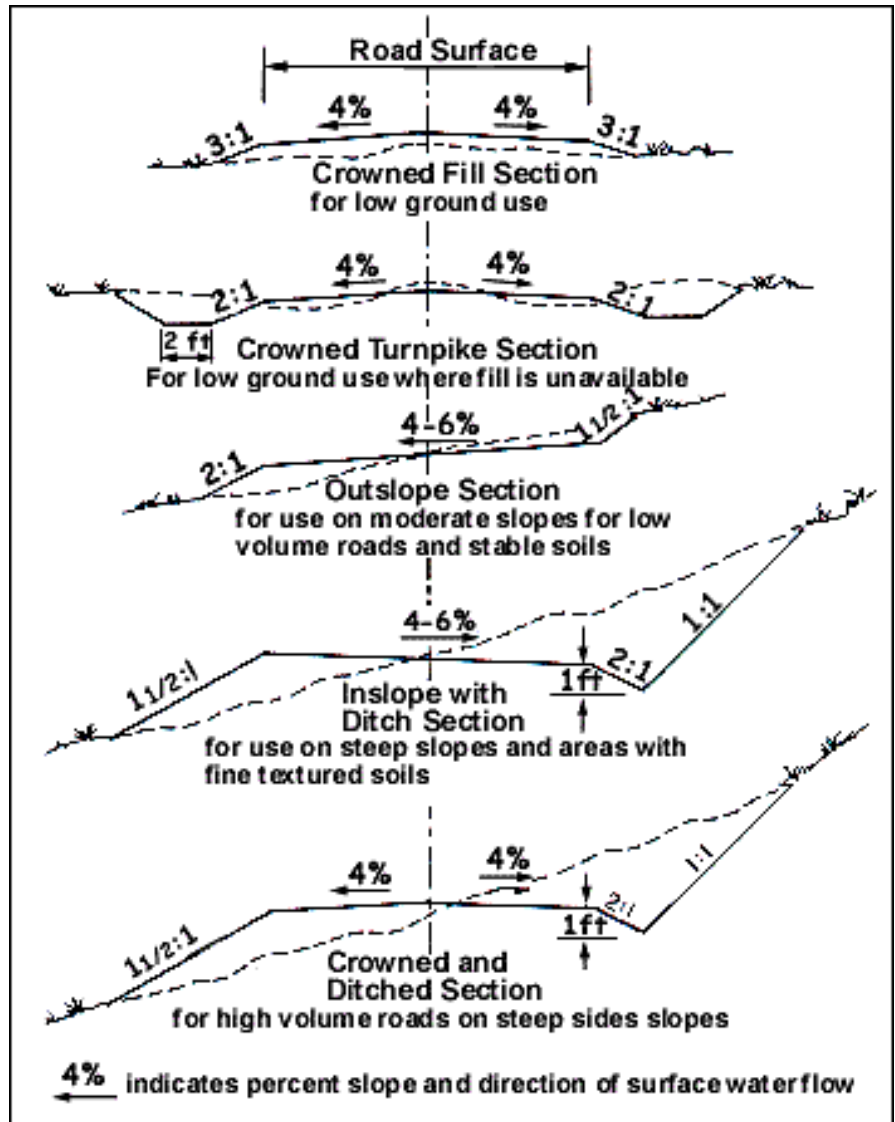

Figure 9. The choice of cross-section for a road or section of a road depends on drainage needs, soil stability, slope, and expected traffic volume. Dashed lines indicate natural land contours, and solid lines indicate constructed road. (Redrawn and adapted from Michigan Department of Natural Resources 1994, p. 23)

A right-of-way agreement should define the road location, its points of ingress and egress, and width. All other pertinent information should be carefully noted. A simple survey may be desirable. Such conditions as the maintenance of fences, gates, and other improvements should be clearly specified. Monetary considerations or other forms of payment requested by the grantor should also be made a part of the agreement. Before executing and recording a right-of-way agreement, consult an attorney.

Should the road end on the right-of-way of a public secondary or primary highway, the local highway department should be contacted. State highway departments have regulations governing the entry of private roads onto public roads.

Return to "A Landowner's Guide to Building Forest Access Roads" [Table of Contents](#)

Road Construction

Before the heavy equipment is engaged and put to work, the road location should be well marked and all preparatory work within the right-of-way should be completed. Marking and preparation will permit immediate and steady use of the machinery and will result in prompt completion at minimum equipment costs. It is important economically that proper size equipment be used.

This section describes the standard road construction phases of clearing, shaping of the roadbed, shaping back slopes, allowing for drainage, and seeding and mulching.

Road Width

It is important to pay close attention to road width during planning and construction. A common mistake is building a road wider than needed for its intended use; it not only adds to the cost of the road, but takes land out of production and renders it useless. Build the narrowest road that will serve your purpose.

If you have problems with wet sections of the road and want the area to dry faster, do not increase the road width. Try improving drainage first (see the section on Road Drainage Methods) or try clearing a larger area so more sunlight can help dry the wet section of road causing problems.

Clearing

Merchantable trees in the right-of-way are cut down and sawn into logs before construction begins. Logs and tops should be moved far enough off the right-of-way that they will not interfere with construction of the road.

Stumps that will be covered by a foot or more of fill material should be cut low but need not be removed. All other stumps and roots over 3 inches in diameter should be dug out of the ground. Leaving a stump about 2 feet high will facilitate its removal with the bulldozer blade. Where the right-of-way supports only brush or young timber, or where a sufficiently heavy tractor-bulldozer is engaged, no felling need be done, and all material can be cleared by machine. Trees moved by bulldozer should not be left leaning or suspended above the ground. They present a hazard that should be eliminated at the time of road construction. Snags that may fall into the road should also be felled. Blasting of rocks and boulders may be necessary on rare occasions, although this need can usually be avoided at the time the road location is planned. Even after construction is under way, it may be possible to bypass such obstacles by minor changes in alignment. If the road has a dead end, sufficient space should be cleared and leveled so equipment can easily turn around.

Road Drainage Methods

This section describes drainage methods that can be used where no intermittent or permanent streams cross the road: water bars, broad-based drainage dips, ditches, outsloping, deflectors, and open top and pole culverts. Depending on the method used, drainage structures would be installed during or after basic construction.

Water Bars

Water bars are narrow structures that may be shallow or deep depending on the need. The deep bars are usually used on roads to be closed to vehicle traffic. Figure 10 shows dimensions for narrow-based water bars. Table 6 shows recommended spacing between water bars.

Water bars can be constructed with hand tools, but bulldozers are most commonly used. It is best to start at the end of the road and work outward so the bars are not damaged by frequent crossing by machinery.



A water bar effectively intercepts surface water and diverts it from the road.

Water bars should be installed at about a 30-degree angle downslope. The outflow end of the water bar should be open to keep water from accumulating and should not flow directly into a stream, to allow the sediment to settle out of the water and to prevent erosion. As a supplement to water bars on roads that will be closed, logging slash can be lopped and scattered on the road, grass can be planted, or both.

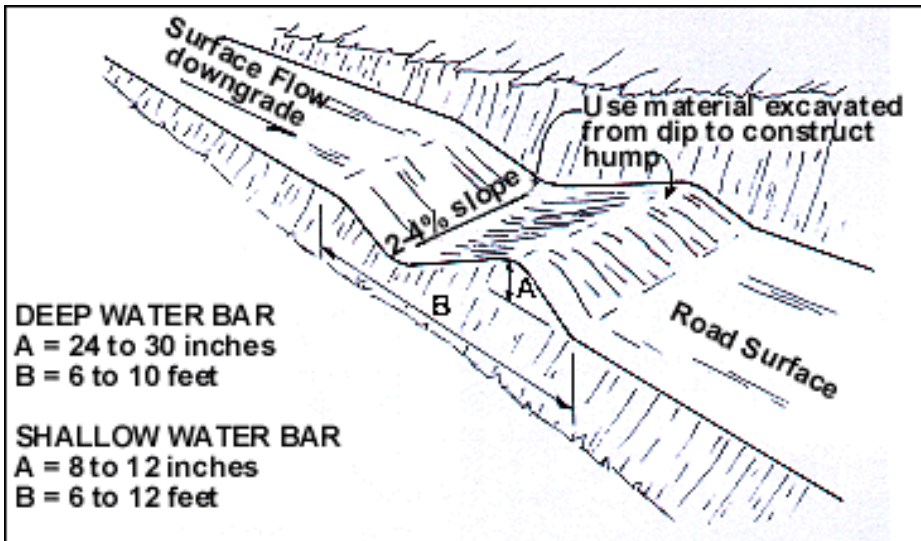

Figure 10. Water bars are narrow structures that may be shallow or deep. Deep water bars are usually used on roads that will be closed for extended periods.

Table 6. Distance needed between water bars

Road grade (percent)	Distance (feet)
2	250
5	135
10	80
15	60
20	45
25	40
30	35

Source: Kochenderfer 1970, p. 28

Broad-Based Drainage Dips

Broad-based drainage dips, which are easily maintained, do not increase wear on vehicles or reduce hauling speed when properly installed. Because of construction characteristics, these dips should not be used on a road with a grade in excess of 10 percent (Figure 11).

Table 7. Distance needed between water bars

Road grade (percent)	Distance (feet)
2 - 4	300 - 200
5 - 7	180 - 160
8 - 10	150 - 140

Source: Kochenderfer 1970, p. 19, 25

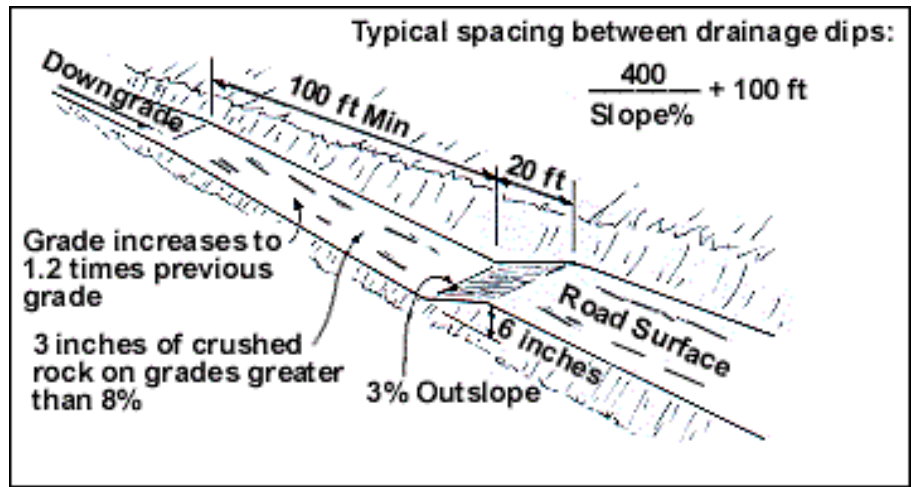

Figure 11. Drainage dips are broad structures used on roads with grades of 10 percent or less.

As for a water bar, care should be taken to ensure adequate drainage at the outflow of a dip. It should never be designed to discharge directly into a stream. The discharge area should be protected with stone, grass, sod, heavy litter cover, brush, logs, or anything that will reduce the velocity of the water. Natural litter may be adequate in many cases if the terrain is not too steep.

Table 7 presents the spacing of broad based dips as computed with the following formula (Kochenderfer 1970):

$$\text{Spacing in feet} = \frac{400}{\text{Slope percent}} + 100$$

Close attention should be paid to construction of broad-based dips, because they are often made too small. Figure 11 shows minimum dimensions. Dips should be armored with crushed rock or gravel.

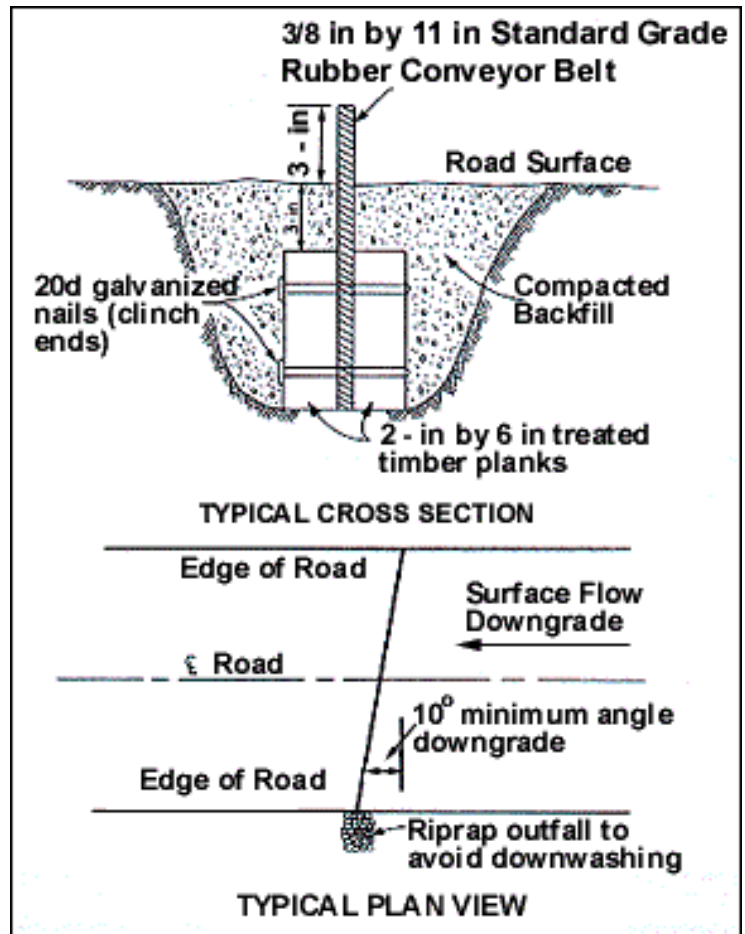

Figure 12. Water deflectors are installed so that only 3 inches of belting extend above the road surface to turn water aside. (Original design by Paul Karr, retired, USDA Forest Service)

Ditches

The construction of ditches is usually restricted to roads where there are frequent springs or seeps. The use of ditches requires that a wider road be cleared. A minimum of 3 percent grade is usually recommended to keep water from standing in the ditch. At a minimum, ditches require annual maintenance to provide proper drainage.

Outsloping

Outsloping a road means building the road surface so that it is tilted outward 4-6 percent so water can run off the road surface (Figure 9, Outslope Section).

Outsloping works well under the right conditions. The following conditions are favorable for use of outsloped roads with no ditch:

Short back slopes

Terrain slope less than 20 percent

Road grades steeper than 3 percent

Seasonal road use

Light traffic

Fast revegetation of cut and fill slopes.



A drainage dip is effective in controlling water on the road and does not significantly slow the speed of vehicles.



A deflector is an alternative method to divert surface water from a road.

Outslopes become a problem if maintenance is not performed when ruts begin to form. The ruts will then act as channels.

The following conditions are unfavorable for outsloping:

Long back slopes

Terrain steeper than 20 percent

Steep continuous road grade

Where ruts occur and allow water to concentrate and run along the road

Where winter hauling is required.

Deflectors

The water deflector is a low cost, low maintenance method to deflect surface water from a roadway, which works as well as an open top culvert. Originally designed by Paul Karr of the USDA Forest Service at Bonners Ferry, Idaho, the water deflector has since been modified by the Engineering Staff of the Lolo National Forest (Figure 12).

The deflector is simply a piece of rubber belting 5/16 inch to 1/2 inch thick fastened between treated timbers. Figure 12 shows a typical deflector installation. Different widths of belting can be used depending on availability. The timbers are installed in the same way as an open top culvert. The only thing showing above the road surface is 3 inches of belting, which deflects the water from the road surface.



A deflector should be installed with approximately 3 inches of belting above the road surface.

The design is simple and works well on low volume and low maintenance roads. The cost for an installed deflector is equivalent to that for an open top culvert. Because there is no abrupt grade change, water deflectors can be used on grades over 10 percent. On roads where farm equipment may have some trouble negotiating broad-based drainage dips, water deflectors would pose no difficulty.

Care is needed when using a road grader to maintain a road with deflectors. Unless the grader operator is careful, the rubber belting can easily be sheared off. This is especially common during winter when the roads are snow covered.

Open Top and Pole Culverts

Open top and pole culverts can be used in place of any of the above-mentioned road drainage methods except outsloping. Open top culverts and pole culverts are inexpensive and easy to construct (Figures 13 and 14). They work well when maintained, but are easily filled with sediment and rendered ineffective within a short period of time when not maintained. Open top and pole culverts are not recommended for crossing live or intermittent streams, and should not be used in lieu of pipe culverts.

Specifications for installation and use of open top and pole culverts follow:

1. Install culverts flush or just below the road surface and angled 10 to 45 degrees downgrade. More maintenance may be required as the angle approaches 10 degrees, 30 to 45 degrees is often times recommended, but this adds length to the culvert.
2. Upper end will be at the same grade as the side ditch and extend into toe of upslope bank.



An open top culvert can be

3. The outlet will extend beyond the road surface with adequate riprap or other material to dissipate water velocity to prevent erosion of fill material.
4. Spacing is the same as for broad-based drainage dips.
5. Use is limited to low water flows and to roads located on flat ground with minimal fill.
6. They are recommended for ongoing operations only and should be removed upon completion of activities.

used for road drainage but should not be used for stream crossings.

Shaping Back Slopes

The best time to shape back slopes is during road construction, because it is more expensive to reshape the road profile after it is constructed.

Back slopes can contribute a significant amount of sedimentation until some type of vegetative cover is established. That is why it is important to seed these areas as soon as conditions are right for this type of activity (usually spring or fall). See Seeding for guidelines.

The angle of repose for the slope, which is the natural slope of the material, will be determined by the types of soil in your area. An example would be a 2:1 back slope, which is 2 feet horizontal to 1 foot vertical slope. Successful revegetation will be greater on gentler slopes. There is little benefit in flattening the slopes beyond the angle of repose, which would increase the area exposed to erosion. Figure 15 gives an example of some common proportions of back slopes and describes the type of treatment needed to stabilize them (Hartung and Kress 1977).

If you have a complex stabilization problem requiring the use of terraces or retaining walls, consult a professional engineer.

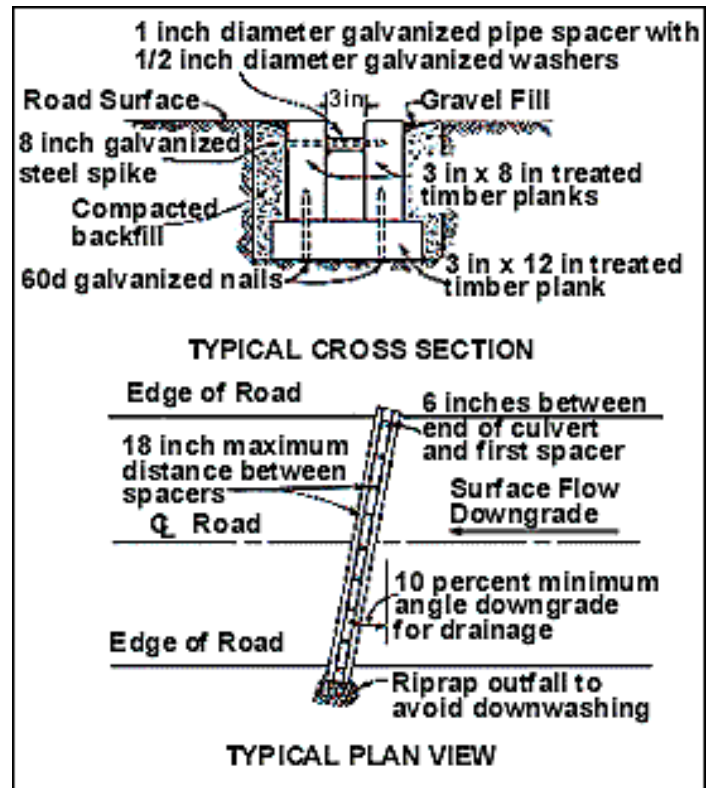

Figure 13. For an open-top culvert to function properly, careful installation and regular maintenance are necessary.

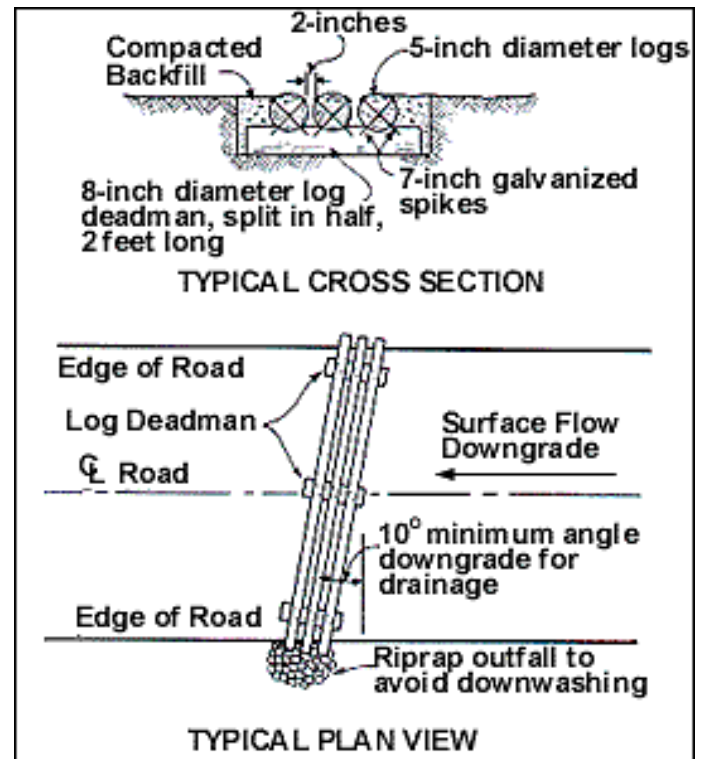

Figure 14. Pole culverts have installation and

maintenance requirements similar to those of open-top culverts. (Redrawn and adapted from Michigan Department of Natural Resources 1997, p. 34)

Seeding and Mulching

Seeding and mulching should be completed as soon as possible to reduce erosion and sedimentation on both cut and fill portions of the road.

Seeding

Seeding is usually accomplished with best results in spring or fall, but results will depend on local weather conditions.

A wide variety of seed is available. Contact your local agronomist, extension agent, county engineer, or the NRCS for a recommended seed mixture for roads in your area. A note of caution: if you have cattle, sheep, or animals that could damage your cut and fill slopes, select a seed mixture less palatable than the surrounding vegetation. Some criteria to look for in selecting a seed mixture are these:

- Fast growing or include a fast growing component in the mix

- Easy to plant

- A compatible mix of perennial and annual seed

- Readily available

- Reasonable cost

- Provides sufficient soil protection by establishing a good root system

- Unpalatable to livestock or other grazing animals.

- Adaptable to soil conditions, for example, drainage, soil depth, aspect, drought tolerance and climate conditions.

Cut and fill slopes should be stabilized, which can be accomplished by reducing them to their natural angle of repose. If not stabilized, slopes will not revegetate and will continue to erode.



The success and quickness of establishing cover may be enhanced by mulching, depending on climate conditions.

Mulching

Straw is the most commonly used mulch material as long as slope gradient, slope length, and rainfall intensity are not excessive. Straw mulch applied at 2 tons per acre is effective in reducing erosion. If weed-free hay is used, seed at a rate of 2 ½ tons per acre. Straw can be used in combination with other bank erosion control measures to increase its effectiveness. Combinations of mulch and netting products are commercially available for areas that are difficult to seed.

SLOPE	TREATMENT
	<p>These slopes sometimes hold without treatment. If the soil is unstable and subject to caving, the bank must be resloped to a lower angle.</p>
	<p>Mulching and fertilization is almost always necessary.</p>
	<p>Can loosen to apply fertilizer and seed; should use light mulch on droughty soils.</p>
	<p>Can cultivate with machinery; drill in fertilizer and seed.</p>

Figure 15. The angle of a back slope, shaped during construction, is determined by the natural angle of repose for the soil type. (Redrawn and adapted from Hartung and Kress 1977, p. 11)

Return to "A Landowner's Guide to Building Forest Access Roads" [Table of Contents](#)

Road Maintenance and Closure

Road Maintenance

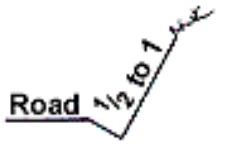
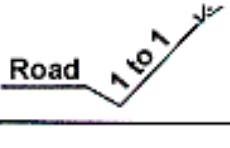
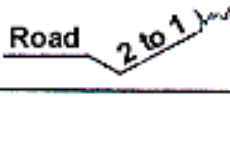
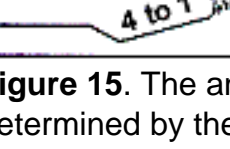
Clearing Culverts and Ditches

Culverts and ditches must be kept free of debris and obstructions. Ditches on newly constructed roads may require frequent cleaning and checking after each major storm until re-vegetation has occurred.

While clearing ditches, follow these guidelines:

- ◇ Leave grass in the ditch unless it has filled with sediment and is no longer functioning.
- ◇ Avoid undercutting the road shoulders and banks.
- ◇ Check culverts for blockage by debris.
- ◇ Do not leave a berm on the side of the road; berms will channel water down the road.

Removing Slide Debris

Slide debris can cause increased sediment loads in established roadway drainage systems as well as in established streams. Do not sidecast removed material if there is a chance it will enter a stream. The cause of the slide needs to be evaluated. Under some circumstances, removal of the slide debris makes the situation worse by further undercutting the toe of the slope. In some instances, removal of some debris may be required and stabilization of the remaining material may prevent further problems. Consult an engineer for advice if the problem persists. General recommendations will not work on slides because there are too many variables that can trigger them, thus local expertise is needed.

Road Closure

Whether a road should be closed is determined by several factors. The type of road and the landowner's objectives are the two most important considerations. The following are some recommendations for closing temporary and permanent seasonal roads.

Temporary Roads

Temporary roads should be closed to reduce the maintenance costs associated with vehicular traffic. Consider doing the following before the last piece of equipment capable of doing road maintenance leaves the site.

- ◇ Remove all temporary drainage structures and replace with water bars.
- ◇ Remove any stream crossing structures and reshape the stream channel to its original contour.
- ◇ Stabilize the roadbed and cut and fill slopes with seed, and mulch when necessary.
- ◇ If public access is a problem close the road with a gate or some other structure at a point where topography prevents vehicles from going around the closure device.

Permanent Seasonal Roads

Permanent seasonal roads should have controlled access to keep maintenance costs low.

- ◇ Ensure the road surface is in stable condition by reshaping to its original specifications. Seed and mulch any remaining disturbed surfaces.
- ◇ Check all drainage structures to ensure they are in proper working order.
- ◇ Remove any logging slash or debris that has the potential to block a drainage structure.
- ◇ Periodically inspect the road to ensure drainage is being maintained.

Return to "A Landowner's Guide to Building Forest Access Roads" [Table of Contents](#)

Stream Crossing Methods

The importance of proper planning for stream crossings cannot be overstated. If stream crossings are not planned and located before road construction begins, you have set the stage for serious problems in the future, including unintended damage to other resources. Requirements for stream crossings vary from State to State. Often a permit is required; check with the water division of your local natural resources agency.

This section covers the simple designs and installation methods for culverts and fords. If you have fish in your stream, also see the section on Protecting Fish Habitat. When selecting the best method to build a road across a stream, the following factors must be considered:

- Stream size
- Debris potential
- Foundation conditions
- Construction cost
- Maintenance costs
- Road use and life.

Three methods are recommended for crossing a stream: bridges, pipe culverts, and fords. Water bars, broad-based dips, and open top and pole culverts should never be used to cross streams. These methods are used to improve drainage (see the section on Road Drainage Methods).

Bridges are not covered here as their construction and design are beyond the scope of this guide. Portable bridges have been widely used in temporary and permanent applications, and are available from several manufacturers. Consult a professional engineer if you are considering a bridge.

Pipe Culverts

Pipe culverts are used primarily to channel water across roadways from uphill drainages or roadside ditches. Spacing would be the same as for water bars (see Water Bars under Road Drainage Methods for spacing).

Historically, pipe culverts were steel or aluminum; however, polyurethane culverts have recently been introduced. These double wall constructed pipes are lighter, easier to handle, and can be cut to length with a handsaw. They may be worth considering, if the price is comparable.

Sizing

Use no smaller than a 15-inch pipe (Helvey and Kochenderfer 1988). If there is evidence of a defined stream channel, use at least an 18-inch pipe. A drainage table provides help in determining the proper size culvert (Tables 8 and 9). An example of how to use the table is provided in the box; however, it is generic. Table 10 can also be used to determine proper culvert size and is easier to use (Helvey and Kochenderfer 1988). The method in Table 10 was developed for Appalachian forests.

Use of Drainage Table

The following example illustrates how to use the drainage table (Table 8) and choose pipe size (Table 9).
 Note: you will need information on slope, soils, and cover.

Example: The area to be drained is 70 acres on steep slopes with heavy soils and moderate cover. In Table 8 under C opposite 70, find area required—10.3 square feet. Under the area table for round pipe (Table 9), this falls between a 42-inch and a 48-inch pipe. Use 42-inch pipe with an area of 9.6 square feet. If a wood or other type of box culvert is planned, one 3 feet by 3.5 feet would furnish the required area.

Table 9. Size of round pipe needed for area of waterway listed in Table 8

Area (square feet)	Pipe diameter (inches)
1.25	15
1.80	18
3.10	24
4.90	30
7.10	36
9.60	42
12.60	48
15.90	54
19.60	60
23.80	66
28.30	72
33.20	78
38.50	84
44.20	90

Source: Figure 45, Haussman and Pruett 1978, p. 36

Table 8. Drainage table based on Talbot's formula for rainfall of 2½ inches per hour

Acres	Area required for waterway*				
	Impervious 100% runoff †C=1.00	Steep slopes Heavy soils Moderate cover C=.80 C=.70	Moderate slopes Heavy to light soils Dense cover C=.60 C=.50	Gentle slopes Agricultural soil & cover C=.40 C=.30	Flatland Pervious soils C=.20
					square feet
2	1.0	0.8 0.7	0.6		
4	1.7	1.4 1.2	1.0		

6	2.3	1.9	1.6	1.4	1.2	0.9	0.6	
8	2.9	2.3	2.0	1.7	1.4	1.2	0.9	
10	3.4	2.7	2.4	2.0	1.7	1.4	1.0	0.6
20	5.8	4.6	4.0	3.5	2.9	2.3	1.7	0.7
30	8.0	6.3	5.4	4.8	4.0	3.2	2.4	1.2
40	9.8	7.8	6.8	5.9	4.9	3.9	3.0	1.6
50	11.6	9.3	8.0	7.0	5.8	4.6	3.5	2.0
60	13.4	10.7	9.2	8.0	6.7	5.3	4.0	2.3
70	15.0	12.0	10.3	9.0	7.5	6.0	4.5	2.7
80	16.6	13.3	11.5	10.0	8.3	6.6	5.0	3.0
90	18.2	14.6	12.5	11.0	9.1	7.2	5.4	3.3
100	19.7	15.8	13.5	11.8	9.8	7.8	5.8	3.6
150	26.9	21.2	18.5	16.0	13.3	10.7	8.0	3.9
200	33.2	26.8	22.9	20.0	16.7	13.3	10.0	5.4
250	39.5	31.5	27.1	23.8	19.7	15.7	11.8	6.6
300	45.7	36.1	31.0	27.1	27.0	18.0	13.5	7.9
350	51.0	40.6	35.0	30.5	25.3	20.2	15.0	10.1
400	56.0	45.0	39.0	33.9	28.0	22.2	16.7	11.2
450	61.7	49.7	42.0	37.0	30.6	24.2	18.0	12.3
500	66.8	52.8	46.0	40.0	33.2	26.5	19.8	13.2
600	77.0	61.6	52.5	46.0	38.0	30.3	22.8	15.3
700	86.0	68.4	59.5	52.0	43.0	34.0	25.8	17.2
800	96.0	76.1	65.8	57.0	47.5	38.0	28.5	19.0
900	104.0	83.0	71.7	62.2	51.9	41.5	31.1	20.8
1000	113.0	90.0	77.7	68.0	56.5	45.0	33.7	22.4

Source: Figure 44, Haussman and Pruett 1978, p. 36

*See Table 9 for size of pipe needed.

† C is the constant factor based on a combination of how much water the soil can hold, slope, and cover. C=.70 is adequate for most conditions prevailing in the Northeast. C=1.00 represents complete runoff of precipitation.

If you need help determining the size of a culvert, your local land conservation department or a private consultant may be of assistance. Make sure they do not size the culverts for a 50- or 100-year storm, unless that is your desire. For low standard or temporary roads, a flood frequency of 25 years can be used.

Table 10. Culvert sizes for drainage areas ranging from 10 to 200 acres for the Central Appalachians. To use this table, determine the size of the drainage area above the stream crossing and the expected life of the culvert (recurrence interval 10, 20, or 50 years). The 20-year values are adequate in most cases within the Central Appalachians. The 50-year values should be used in more northern locations.

Area (acres)	Recurrence interval (years)		
	10	20	50
10	16	16	18
20	18	18	20
30	18	20	24
40	20	22	26
50	22	24	28
60	22	24	28
70	24	26	30
80	24	26	30
90	24	28	32
100	26	28	34
125	28	30	36
150	28	32	38
175	30	34	40
200	32	36	42

Source: Table 3, Helvey and Kochenderfer 1988, p. 125

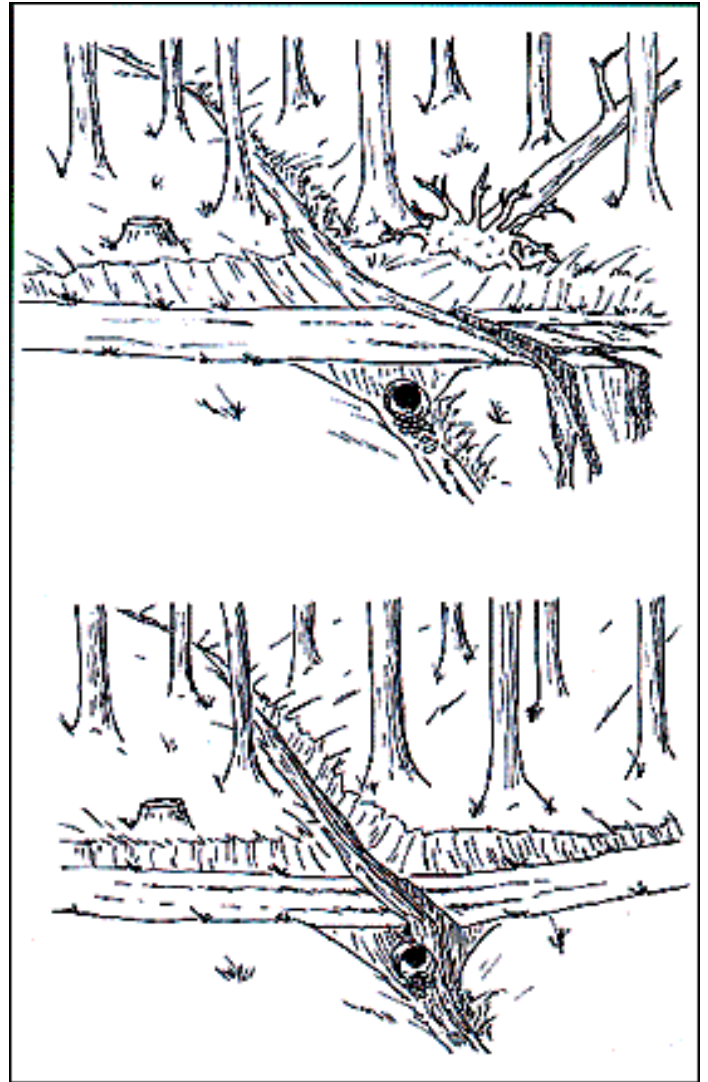

Figure 16. It is important to plan for the failure of a stream crossing, to reduce the amount of sediment that would enter the stream channel should the crossing fail. (Redrawn from Furniss et al. 1991, p. 310)

Installation

Stream crossings, such as culverts, can be considered dams that are designed to fail. The risk of culvert failure is substantial for most crossings, so *how* they fail is critical. In the upper sketch in Figure 16, the crossing has failed and the road grade has diverted the stream down the road, resulting in severe erosion and downstream sedimentation. Such damage to aquatic habitats can persist for many years. Stream diversions are easy to prevent, as illustrated by the lower sketch, in which the road grade was such that a failed crossing caused only the loss of some road fill (Furniss et al. 1991).

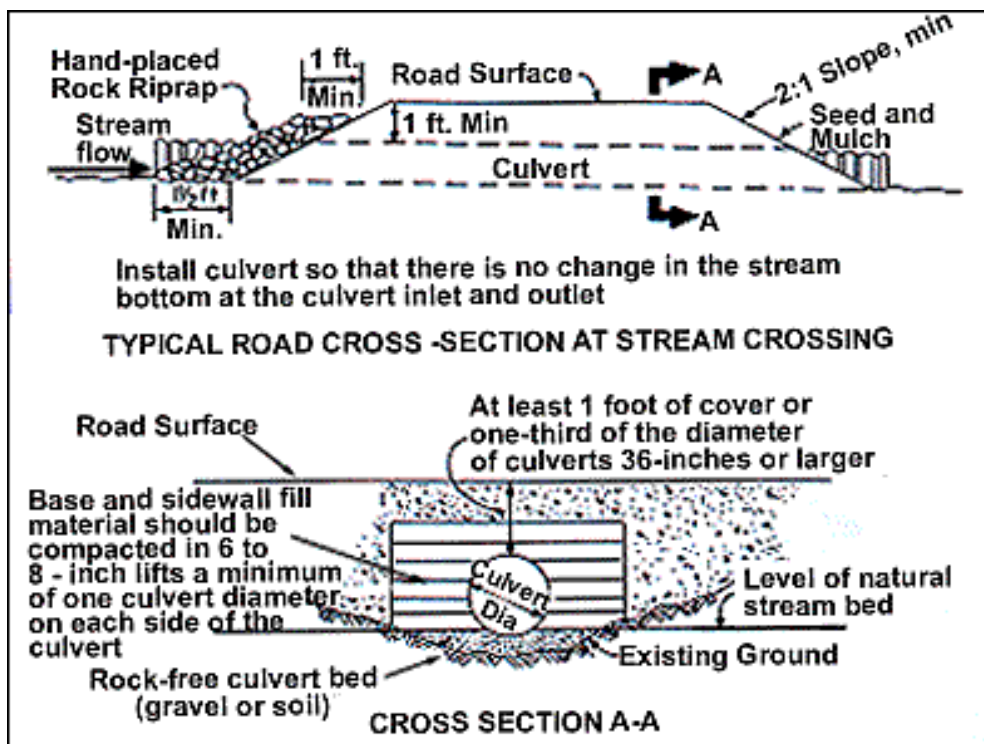

Figure 17. A cross section of a culvert at A-A shows the recommended structure of fill material installed around a culvert pipe. (Redrawn and adapted from Figures 6-5 and 6-6, Wisconsin Department of Natural Resources 1995, p. 26)

Culverts should be installed as the road work progresses. The culvert and its related drainage features should be installed in the following order:

1. Place debris and slash to be used as a filter system, if needed.
2. Construct sediment ponds, if needed.
3. Complete downstream work first, such as energy dissipating devices and large rock riprap.
4. Route stream around work area until pipe is installed.
5. Construct pipe inlet structure.
6. Install culvert pipe.

A culvert inlet should be placed on the same level as the stream bottom. In some instances where the culvert inlet has to be lower than the drainage gradient, a drop box can be constructed. This box, which is a place for sediment to settle out before water enters the culvert, needs frequent maintenance.

Install culvert pipes as near as possible to the gradient of the natural channel and so there is no change in the stream bottom elevation (Figure 17 top). Culverts should not cause damming or pooling. Seat the culvert on firm ground and compact the earth at least halfway up the side of the pipe to prevent

water from leaking around it. Pipe culverts must be adequately covered with fill; the rule is a minimum of 12 inches or half the culvert diameter, whichever is greater (Figure 17 bottom).



Culverts not installed at the same level as the stream cause water to back up.

If adequate cover cannot be achieved, then an arch pipe or two small culverts should be installed. The cover must also be compacted to prevent settling in the road. Debris-laden material should not be used to cover pipe culverts.

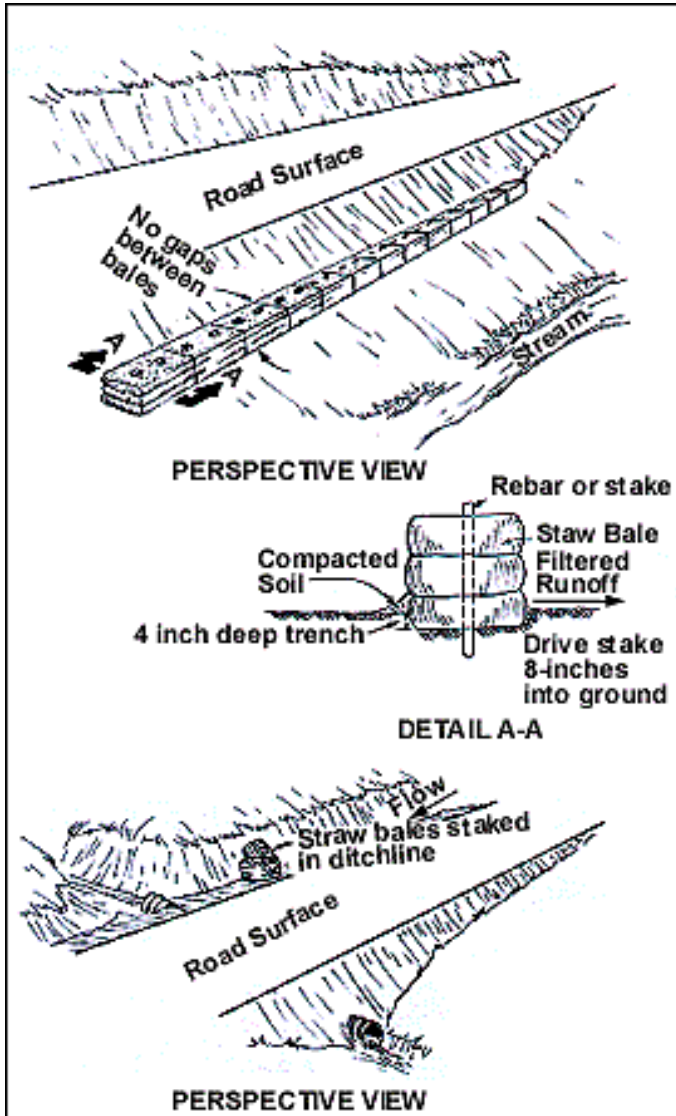

Figure 18. Use stabilization practices on soil exposed at stream crossings during

The following are additional guidelines for installing culverts in streams:

Limit construction activity in the water to periods of low or normal flow. Minimize use of equipment in streams.

Use soil stabilization practices on exposed soil at stream crossings. Seed and mulch and install temporary sediment control structures, such as silt fences made of straw bales or geotextiles immediately after road construction, to minimize erosion into streams (Figure 18). Maintain these practices until the soil is permanently stabilized.

Use materials that are clean, nonerodible, and nontoxic.

To prevent erosion and under-cutting of the inlet end of the culvert, provide a headwall. Sandbags containing some cement mixed with the sand, durable logs, concrete, or hand-placed riprap are suitable (Figure 19).

Maintenance

Keep culverts clear and free of debris so water can pass unimpeded at all times. Culvert failure is caused by blockage with debris as often as by the culvert's capacity being exceeded. For this reason, avoid leaving excess amounts of woody debris in stream channels where it can float downstream and lodge in culverts. All culverts should

construction, until the soil is permanently stabilized. (Detail A-A redrawn and adapted from Figure 6-13a, Wisconsin Department of Natural Resources 1995, p. 35)



Undersized culverts can become plugged with sediment

be checked after major storms and at least twice per year—in spring and fall (Helvey and Kochenderfer 1988). Maintenance is especially important in areas where beavers are present.



A culvert not installed at the existing stream gradient can degrade the stream channel.

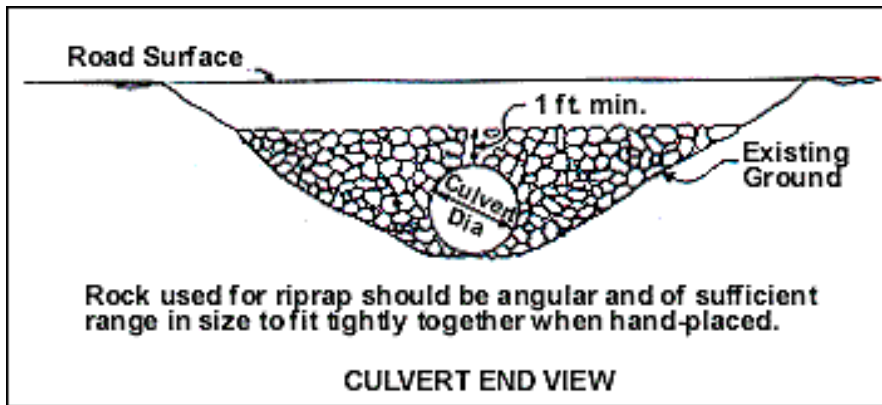

Figure 19. Install riprap to prevent erosion at the inlet to a culvert pipe.



Fords can be an economical method of crossing streams under certain low water conditions and when properly located and designed.

Fords

A ford is an alternative way to cross a water course under the following circumstances:

1. The streambed has a firm rock or coarse gravel bottom, and the approaches are low and stable enough to support traffic.
2. Traffic is limited to low volumes of light vehicles.
3. Water depth is less than 3 feet.
4. If corduroy, coarse gravel, or gabion is used to create a driving surface, it should be installed flush with the streambed to minimize erosion and to allow fish passage.
5. Crossings should be at right angles to the stream.
6. Stabilize the approaches by using nonerodible material. The material should extend at least 50 feet on both sides of the crossing.

Return to "A Landowner's Guide to Building Forest Access Roads" [Table of Contents](#)

Protecting Fish Habitat

Protection of fish habitat is necessary for stream crossings where fisheries exist. The choice of crossing location is important in terms of both sedimentation effects and fish passage. For fish passage, preferred locations are those that do not cause large increases in velocity and have no abrupt changes in gradient or alignment of the channel. Sections of a stream with uniform alignment, good bank stability, and uniform gentle gradients are easier to cross with provisions for fish passage.

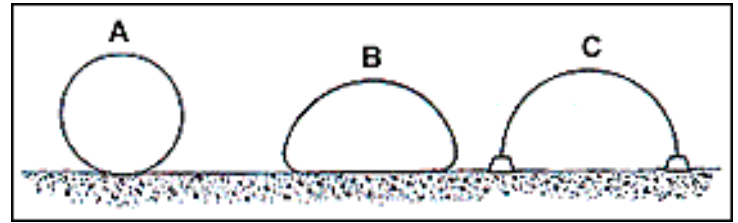

Figure 20. The three common types of metal culverts are classified by shape: (A) corrugated round, (B) corrugated pipe-arch, and (C) structural plate-arch. (Redrawn from Furniss et al. 1991, p. 316)

Road crossings can be barriers to fish migration, usually because of outfall barriers, excessive water velocity, and insufficient water depth in culverts (Yee and Roelofs 1980). Determine the type and extent of fish habitat before selecting drainage structure design. The incorporation of fish-passage facilities at stream crossings should be based on assessments of the life-cycle requirements of fish species, of habitat quality, and of the accessibility of sites to fish. Natural barriers downstream or immediately upstream from the site may eliminate the need to provide fish-passage facilities. Usually, a fisheries biologist must be consulted to assess the habitat. Contact your State or local fisheries biologist to determine the specific needs of the fish in your streams.

Fords are sometimes used for low-water crossings where transportation requirements are seasonal and stream channel and slope configurations are suitable. Fords with concrete sills or grade-control structures can be barriers during low-flow conditions, but they can usually be mitigated in the design. Fords are preferable to culverts for fish passage because high-flow migration is unimpaired and low-water migration is easy to accommodate. See the section on Stream Crossing Methods for more information about using fords.

Bridges and arch culverts are preferred for crossing streams with migratory fish. Bridges and arch culverts are beyond the scope of this guide, and appropriate assistance should be sought in designing and constructing them. Bridges are preferred because they usually cause less modification of the stream than do culverts, and are often the best way to ensure fish passage. Culverts are by far the most common type of crossing device and the most likely to cause barriers to fish migration. This section covers common metal culverts and avoiding barriers to fish passage.

The three types of metal culverts commonly used are classified by shape (Figure 20): (A) standard corrugated-round, (B) standard corrugated pipe-arch, or (C) structural plate-arch. The first two may be prefabricated, as is usual for the smaller sizes up to 4.5 feet in diameter, or they may be of multiple design. Structural plate-arch culverts are always of multiple design because they are so large, and usually are fabricated on site.

Round culvert

Although the standard corrugated-round culvert (Figure 20A) is the type most commonly used, it is the least desirable for fish passage. The width constriction from stream channel to culvert is usually severe, and the gradient of the pipe should be less than 1 percent to keep water velocities within an acceptable range for fish passage. This type of culvert is also the most likely to be installed with its outlet end elevated above the tailwater level, producing an outfall barrier (Figure 21). Elevated outfalls must be avoided or mitigated. See Culvert Outfall Barriers for mitigation measures.

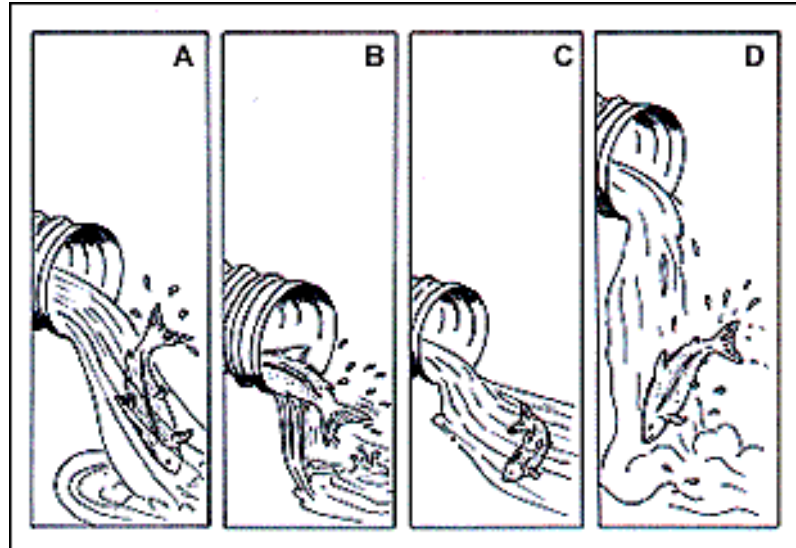

Figure 21. Improperly installed culverts can block fish passage: (A) water velocity too great, (B) water in culvert too shallow, (C) no resting pool below culvert, and (D) jump too high. (Redrawn from Evans and Johnston 1980)

Pipe-arch culvert

The pipe-arch culvert (Figure 20B) is less desirable than the structural plate-arch, but can usually be installed to allow fish passage. Fabricated in smaller sizes, the pipe-arch culvert can be used in smaller, lower fills where structural steel arches would not fit. Wherever a pipe arch is used, the gradient must be kept below 1 percent to minimize water velocities. During periods of low flow, the water in this type of culvert can be spread so thinly across the bottom that fish passage is impossible. Baffles may be needed to increase the flow depth through the pipe arch.

Structural plate-arch culvert

The structural plate-arch set in concrete footing (Figure 20C) is the most desirable culvert type for fish passage because the natural streambed is left mostly unchanged. Little narrowing of the flow occurs at either end of the culvert, and there is no significant change in water velocity. Where concrete footings are not practical, split, wide-flanged, buried steel footings have been used successfully. Many fisheries biologists believe the structural plate-arch is the only acceptable culvert type where fish passage is required (Furniss et al. 1991).

Culvert crossings have been installed in thousands of streams with little or no thought to their effects on fish populations. A single, poorly installed culvert can eliminate the fish population of an entire stream system.

The following are some important considerations for culvert installation (Furniss et al. 1991, Yee and Roelofs 1980):

- ◇ The two most important considerations for fish passage through culverts are maximum acceptable water depth for the migrating species, and outfall.
- ◇ The culvert should be placed at or below the original streambed elevation, and water depth and velocity at low and high flows should be integrated into the design.

- ◇ Control scouring at culvert outlets with energy dissipators such as heavy rock riprap consistent with fish passage considerations.
- ◇ At stream crossings, avoid channel width changes and protect embankments with riprap.
- ◇ Align culverts with the natural course and gradient of the stream.
- ◇ Locate valley-bottom roads to provide a buffer strip of natural vegetation between the road and stream. For recommended buffer widths, see Table 1.
- ◇ Select periods of low flows for construction to limit disturbance.
- ◇ Design and construct a stream crossing so that if the culvert should fail, the stream flow will not be diverted out of the original channel (Figure 16).
- ◇ Ensure erosion-control measures are completed before the wet season in your area.
- ◇ Locate fuel storage areas away from the stream. Construct dikes to contain the largest possible spill.
- ◇ If gravel removal operations are permitted in the streams, coordinate the removal with a fisheries biologist who can give beneficial information to protect your fisheries.
- ◇ The diameter of culverts must be adequate to allow maximum flows and the expected debris to pass. Washing out of culverts and their earth fills damages the road and is a source of sedimentation. Channel bank stability upstream and downstream of culverts should be provided for. Road crossings alter the hydraulics of streams above and below the crossings for considerable distances, sometimes making streambanks more susceptible to erosion. Severe erosion can alter the configuration of the stream and crossing, and can eliminate the design components that provide for fish passage.
- ◇ A single large culvert is better than several small ones because it is less likely to become plugged, and carries water at low velocities.
- ◇ Where culverts are installed in stream sections with steep gradients, it is important to create or improve resting pools, cover, and bank protection along the stream above and below the culverts. Maintaining a stable stream bottom through the culvert-influenced area is essential.

Culvert Outfall Barriers

Culverts can be insurmountable barriers to migrating fish when the outlet of the culvert is so far above the tailwater that fish cannot enter the pipe. This condition is an outfall barrier (Figure 21). When new culverts are to be installed on streams with migrating fish, every attempt should be made to avoid constructing outfall barriers. Putting a new culvert outlet below the tailwater elevation is sometimes not possible, and many existing culverts form outfall barriers.

One way to correct an existing outfall barrier is to provide for one or a series of low-end dams below the culvert outfall. These dams may be nothing more than hand-placed rock "reefs," wirebasket gabions filled with local rock, or concrete sills. These downstream dams raise the tailwater elevation and flood the culvert. Access by fish is not only enhanced, but water velocity in the culvert is decreased. The downstream dams should not create outfall barriers.

In some streams, the range of flows is so great that it is impossible not to have the culvert outlet above the tailwater at some time. Also where severe fluctuations in flow require large culverts, fish passage may be impeded during low flows because of shallow flow over the broad culvert bottom. In such cases,

stacked- or multiple-culvert installations can be used to provide fish passage. Placing the stacked culverts at different elevations ensures adequate discharge capacity as well as fish passage over a wider range of flows.

Structures for Debris Control

Trash racks are detrimental to fish passage. The storms that often bring debris downstream are those in which many fish can move up to spawning areas. Although the protected culvert may not be a velocity or outfall barrier, a debris-laden trash rack can be impassable to fish. Therefore, debris-catching structures should be avoided on streams used by migrating fish, and crossings should be large enough to transmit debris downstream. However, increasing the culvert diameter may be impractical because of the increased cost.

To compensate for the absence of culvert protection from avoiding debris-catching structures, the culvert should be large enough to allow debris to pass through it. Passing debris through the culvert is a valid alternative to intercepting debris above the culvert inlet, and should not be overlooked.

Roads can have substantial adverse effects on fisheries. These effects can be greatly reduced if the protection of fish habitats is integrated into the planning, design, construction, and maintenance of roads.

Return to "A Landowner's Guide to Building Forest Access Roads" [Table of Contents](#)

Recommendations for Wetland Forest Roads

If crossing wetlands cannot be avoided, contact your State natural resources agency for rules and regulations, which may vary from State to State. The landowner is strongly advised to use the services of a forester and a professional engineer to develop complete design and construction specifications for roads through forested wetlands.

Forested wetlands can be divided into three types: mineral soil wetlands, shallow peat wetlands, and deep peat wetlands. Roads in both mineral soil and shallow peat wetlands may be constructed using conventional road construction techniques for cut and fill, and drainage structures. Special construction methods must be used for roads on deep peat wetlands.

This section gives general recommendations for planning, designing, and constructing roads in any of these wetland types. Geotextiles can be used to solve drainage problems in any wetland type. Recommendations are also given for road construction during winter, which can minimize adverse effects to the wetland and reduce costs.

General Planning and Design

- ◇ Minimize total wetland road mileage when wetlands must be crossed, while still meeting landowner objectives.
- ◇ Determine the type and depth of wetland subsoils to ensure proper road design and construction.
- ◇ Minimize width of roads consistent with maintaining safety and road design considerations. Provide turnouts, as appropriate, at intervals to accommodate two-way traffic. On deep peat wetlands, road fill slopes should be 3:1 or flatter to spread out road loading and minimize failure (Figure 9, Crowned Fill Section).
- ◇ Construct all road embankment fills with material free of stumps, roots, and duff.
- ◇ Design upland road approaches to wetlands so surface runoff is diverted before entering the wetland.
- ◇ Anchor temporary structures at one end to allow them to move aside during high-water flows.
- ◇ Remove temporary fills and structures to the extent practical when their use is complete.
- ◇ Employ sediment control techniques (such as silt curtains) to prevent sediment movement to open water when placing fill during construction.
- ◇ Provide adequate cross-drainage by employing one or both of the following techniques:
 1. Construction methods that allow free water flow throughout the entire roadbed (Figure 22).
Culverts or other cross-drain structures at each end of each wetland crossing and at intermediate
 2. low points. Space culverts or other cross-drain structures at maximum 300-foot intervals to ensure adequate cross-drainage through the roadbed (Figure 23).

Construction

Choosing the appropriate road construction technique depends on a knowledge of water table position, zone of water flow, and type and strength of wetland soils. With any road construction technique in wetlands, culverts, ditches, or both may be necessary.

Follow these recommendations when constructing ditches on wetland roads:

- ◇ Construct ditches, where necessary, to intercept and carry surface and subsurface water (the top 12 inches) to, through, and away from culverts. Unditched openings should be left midway between culverts (Figure 23).
- ◇ Avoid having ditches create additional outlets that will result in drainage of the wetland.

Additional methods used for drainage ditches are listed under guidelines that follow for crossing specific wetland types.

Crossing Mineral Soil Wetlands

Wetlands with mineral soils include those wetlands having fine-textured (clay or silt), slowly permeable soils to sandy soils overlaying impervious subsoils or hardpans. Road building across these wetland types employs conventional road construction techniques for road fill and drainage structures.

These weak mineral soils can be excavated and backfilled with clean granular soils, or they can be covered with clean granular fill and allowed to compress and displace. Additional fill is added to keep the roadbed at the desired grade.

Culverts and ditches are installed to minimize disruption of normal water flow across the landscape and transport water through and away from the roadbed. Install culverts of sufficient size to handle hydrologic flows for the site and for long-term maintenance needs. If ditches are needed, construct them immediately adjacent to the toe of the fill slope. Filled areas in flow planes should be designed to allow high flows to pass unimpeded.

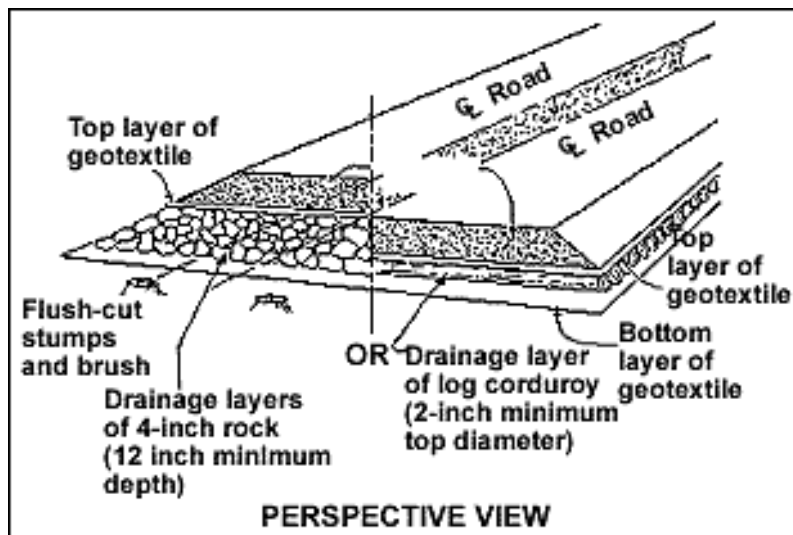

Figure 22. Proper roadbed construction in peat wetlands allows free water flow. (Redrawn and adapted from Minnesota Department of Natural Resources 1995, p. 50)

Crossing Shallow Peat Wetlands

Roads in wetlands with peat soils less than 4 feet deep may be constructed using conventional construction methods. The conventional road construction method consists of excavating the shallow peat and then backfilling with clean granular material. The excavated peat can be used to flatten the roadbed fill slope. Excess peat should be hauled away and disposed of at an approved upland disposal site.

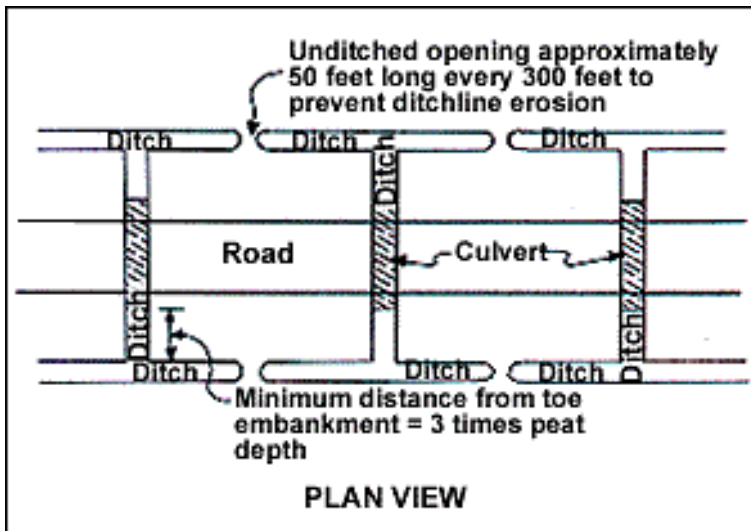

Figure 23. Adequate cross-drainage throughout the road length is essential in deep peat wetlands. (Redrawn from Minnesota Department of Natural Resources 1995, p. 51)

Another accepted road construction method involves placing granular fill material directly onto the peat surface. The weight of the fill material displaces (or pushes aside) the weaker peat until the strength of the subsoils is sufficient to bear the weight of the fill material and vehicle loadings. As final settling occurs, additional fill may be needed to maintain the desired road grade.

With both methods, culverts and ditches are installed to intercept surface and subsurface water flow, transporting it through and away from the roadbed. Most subsurface flow occurs in the top 12 inches of the peat.

Follow these recommendations when placing culverts:

- ◇ Install culverts that are a minimum of 24 inches in diameter buried halfway below the soil surface (Figure 24). The upper half will handle surface storm flows and the lower half will handle normal subsurface water flows. Failure to bury the lower half of the culvert will cause subsurface water to pond on the upstream side of the road and to kill trees.
- ◇ Place culverts at the low points of the wetland to allow surface water flows to pass through the road embankments. If ditches are needed, construct them immediately adjacent to the toe of the fill slope.

Crossing Deep Peat Wetlands

Roads in wetlands with peat soils greater than 4 feet deep can be constructed using special construction methods that do not require excavation and backfilling. These methods use geotextile fabrics, special embankment structures (such as lightweight road fills, extra-wide road bases, or log corduroy layers), and the inherent strength of the underlying peat layers to resist slip failure and resultant road failure (Figure 22).

Road failure in deep peat wetlands can range from the gradual sinking to the sudden loss of the road into the wetland. When such failures occur, water flow through the peat wetland is greatly

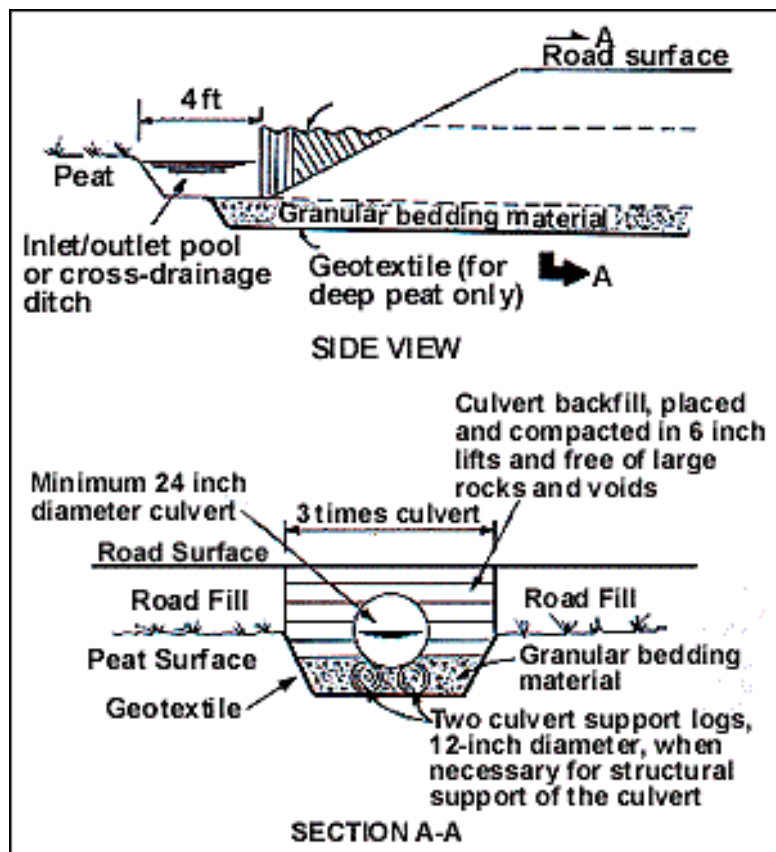

disturbed, which can result in large areas of flooding.

Figure 24. Proper culvert height is lower in wetlands than in other forest conditions, to accommodate subsurface flow. (Redrawn and adapted from Minnesota Department of Natural Resources 1995, p. 55)

Recommended construction methods generally specify that a layer of geotextile fabric be placed on the peat surface. Road fill is then placed over the geotextile. To provide additional strength and adequate cross-drainage, special materials such as log corduroy, chunkwood, or wood chips may be added in the lower portion of the fill (Figure 22).

The specific road structure needed depends on the strength of the peat layers underneath the road. The determination of shear strength is critical in designing a sound, safe, and economical road. Consult the services of a registered civil engineer to accurately determine shear strengths, conduct field tests, and provide design specifications.

Some deep peat wetlands with peat layers too weak to support a roadbed will require traditional excavation and backfill methods. Because of the high cost of traditional construction methods, as well as adverse effects to the wetland, it is best to avoid building on these weak peat wetlands.

Cross-drainage through the roadbed in a deep peat wetland is normally slowed or halted as a result of the compression of the peat layers by the road embankment, rutting of the peat surface by construction equipment, or road failure. This slowing of cross-drainage can cause flooding on the upslope side of the wetland and drying on the downslope side.

Cross-drainage can be maintained by the proper installation of culverts and drainage layers. In all cases, the construction objective is to provide a stable road surface while maintaining the free flow of water through the roadbed.

The following construction techniques can prevent or minimize adverse impacts to deep peat wetlands:

- ◇ Construct road embankments when the peat is frozen. Construction on frozen peat avoids ruts and other damage to the topmost root mat layer which normally contains considerable shear strength. Damage to this root mat can greatly reduce the strength of the upper peat layers and reduce the ability of wetland subsoils to hold up the weight of the roadbed and vehicle loads.
- ◇ Maintain a separation between the toe of the embankment fill slope and the ditch when constructing ditches parallel to the roadway. The separation distance should be at least three times the depth of the peat (Figure 23), to prevent or minimize disturbance of the inherent strength of the top layer of peat containing the root mat.
- ◇ Provide ditches to facilitate water flow into and out of culverts (Figure 23). Construct ditches using flotation devices, such as timber mats, or schedule construction during frozen conditions, to prevent or minimize adverse impacts on wetlands and minimize damage to construction equipment.
- ◇ Construct ditches using flotation devices, such as timber mats, or schedule construction during frozen conditions, to prevent or minimize adverse impacts on wetlands and minimize damage to construction equipment.
- ◇ Obtain advice from professional engineers on designing cross-drainage ditches for permanent seasonal roads across deep peat wetlands.

Methods for Crossing Wetlands Using Geotextiles

Geotextiles and their uses are described in a separate section later in this guide. Roadbeds that use geotextile fabrics should be prepared to protect the woody root mat by flush-cutting trees and brush and leaving nonmerchantable material in place. The first geotextile fabric should be laid loosely over the cut material. Then proceed with road construction using log corduroy, a rock drainage layer, or lightweight road fill. Construction techniques follow.

Log corduroy

- ◇ Place trees parallel to each other, side by side, and perpendicular to the roadbed direction.
- ◇ Cover trees with clean road fill or gravel.
- ◇ If log corduroy is to be used for cross-drainage, apply geotextile both above and below the corduroy. If log corduroy is not to be used for cross-drainage, other cross-drainage structures should be considered (Figure 22).

Rock drainage layer

- ◇ Place 12 inches of rock (4 inches or less in diameter) over the geotextile, followed by another layer of geotextile. The rock layer will settle into the top 12 inches of the wetland, providing the pore space for water passage through the roadbed.
- ◇ Place clean road fill or gravel (typically 18 inches deep) on top of the rock.

Lightweight road fill

Lightweight materials may be incorporated into the core of the road embankment fill to lessen the total weight of the road embankment when constructing on weak peat wetlands. Lightweight materials include chunkwood, wood chips, and sawmill residues, among other materials. Materials with known potential to leach toxic substances, such as construction debris, treated wood, tires, asphalt, or other petroleum-laden materials are not suitable for use.

- ◇ Place the lightweight materials over geotextile fabric to form the core of the road embankment fill, followed by another layer of geotextile fabric over the lightweight materials.
- ◇ Cover the core with at least 18 inches of granular sand or gravel.
- ◇ Install culverts and ditches, if necessary, to allow surface and subsurface waters to pass through the road embankment (Figure 23).

Crossing Wetlands in Winter

Roads are often constructed across wetlands in winter to take advantage of frozen ground conditions. Follow these recommendations to cross all wetland types in winter:

- ◇ Plan the road layout to maximize operating efficiency and minimize site disturbance.
- ◇ Select the shortest practical routes that minimize potential problems with drifting snow and the crossing of open water.

- ◇ Tamp and pack the wetland area wider than needed for the driving and working area if sufficient frost is not present. This additional space will allow for turnouts, snow removal, and parking.
- ◇ Avoid crossing open water or active springs. If these are unavoidable, temporary crossings are preferred. These can be ice bridges, temporarily installed bridges or culverts, or timber mats.
- ◇ Avoid using soil fill.
- ◇ Install any structures that will block water flow so they can be easily removed before ice breakup. If the streams are navigable or require a permit to cross, removal may be necessary at the end of each winter of operation, not just at the end of the timber contract.
- ◇ Use planking, timber mats, or other support alternatives to improve the ability to support heavy traffic.
- ◇ Anchor temporary structures at one end to allow the structure to move aside during high-water flows.
- ◇ Remove temporary fills and structures to the extent practical when use is complete.
- ◇ Avoid clearing practices that result in berms of soil or organic debris building up on either side of the road clearing. Such berms can disrupt normal water flow.
- ◇ Provide buffer strips near open water.
- ◇ Cease equipment operations on any portion of the road where ruts exceed 6 inches below the water surface for a continuous distance longer than 300 feet. Resume operations only when conditions are adequate to support equipment. This practice will minimize blockage of cross-drainage through porous peat and prevent or minimize down-road channelization (Figure 25).

Cease equipment operations on any portion of the road where ruts exceed 6 inches below the water surface for a continuous distance longer than 300 feet. Resume operations only when conditions are adequate to support equipment. This practice will minimize blockage of cross-drainage through porous peat and prevent or minimize down-road channelization (Figure 25).

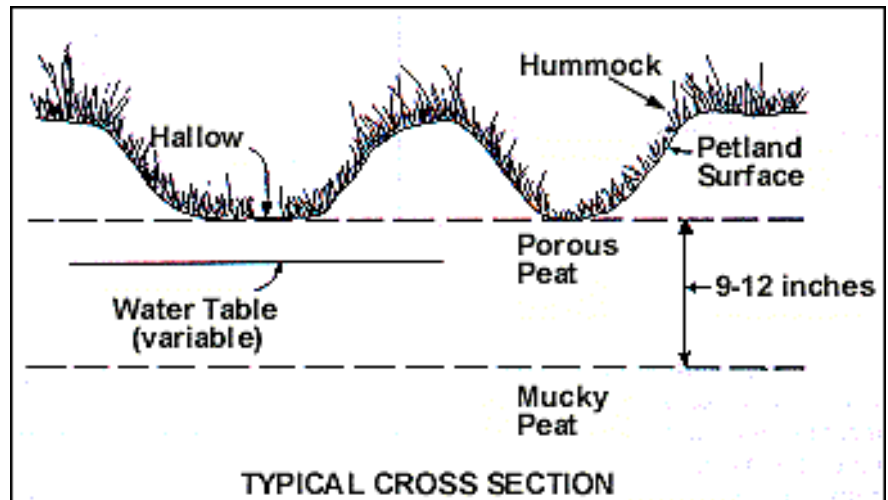

Figure 25. Ruts deeper than 6 inches below the water table in porous peat can take up to 20 years to heal. (Redrawn from Minnesota Department of Natural Resources 1995, p. 63)

Return to "A Landowner's Guide to Building Forest Access Roads" [Table of Contents](#)

Dealing With Beavers

In many situations, removal of beavers and their structures is neither desirable nor cost-effective. Furthermore, it is difficult to prevent beavers from colonizing suitable habitat. Attempts to discourage beaver colonization in areas of high beaver density are usually ineffective.

A long-term approach may be to eliminate potential food sources for beavers near suitable aquatic habitat, for example, plant spruce or pine in riparian areas. However, beavers often cut aspen trees 100-150 yards from water. Furthermore, this option does not solve immediate drainage problems caused by beaver ponds.

There are no registered, practical, effective, environmentally safe chemical toxicants, biological control agents, aversive agents, fumigants, or repellents available for specific use against beavers (D'Eon et al. 1995).

Removal of dams, lodges, or both, is probably the most used, but least effective method of discouraging beavers. The usual response is a repaired dam or lodge by the following day (Buech 1985).

Live-trapping and relocating beavers is expensive. It is also difficult because another site that is not already inhabited is usually difficult to find. Some States have trapping programs, but these are generally small programs and should not be depended upon to solve a local landowner's problems. Should the decision be made to trap or shoot beavers, contact your State natural resources agency for rules and regulations, which may vary from State to State.

Installation of water control devices is worth considering if some degree of elevated water is tolerable. This is especially true where water crossings are degraded or annual maintenance costs are high as a result of beaver activity. In addition to economic considerations, many landowners want to maintain beavers on their property.

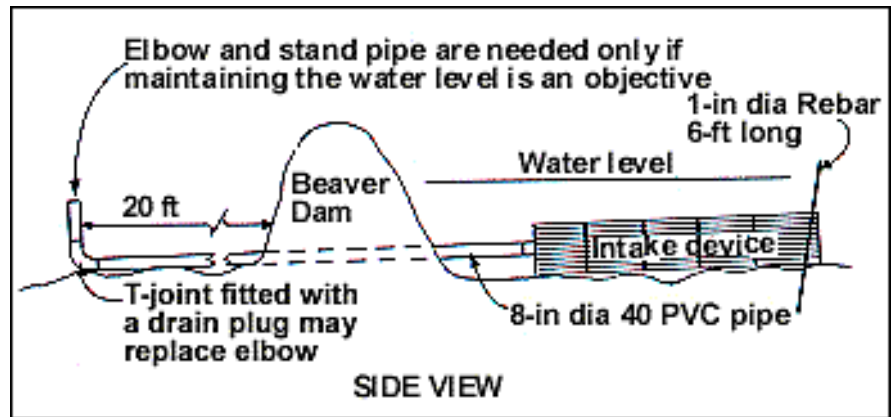

Figure 26. The Clemson Beaver Pond Leveler is a low-cost, low-maintenance solution. (Redrawn from Wood et al. 1994, p. 2)

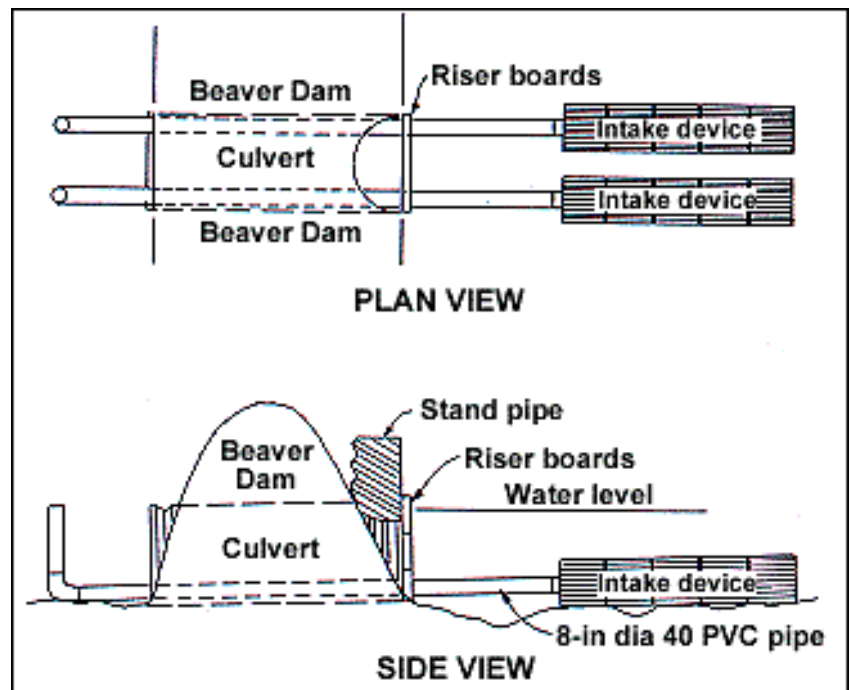

Figure 27. The Clemson Beaver Pond Leveler helps solve plugging of road culverts, as well as filling of stand pipes and culverts used as water control structures. (Redrawn from Wood et al. 1994, p. 3)

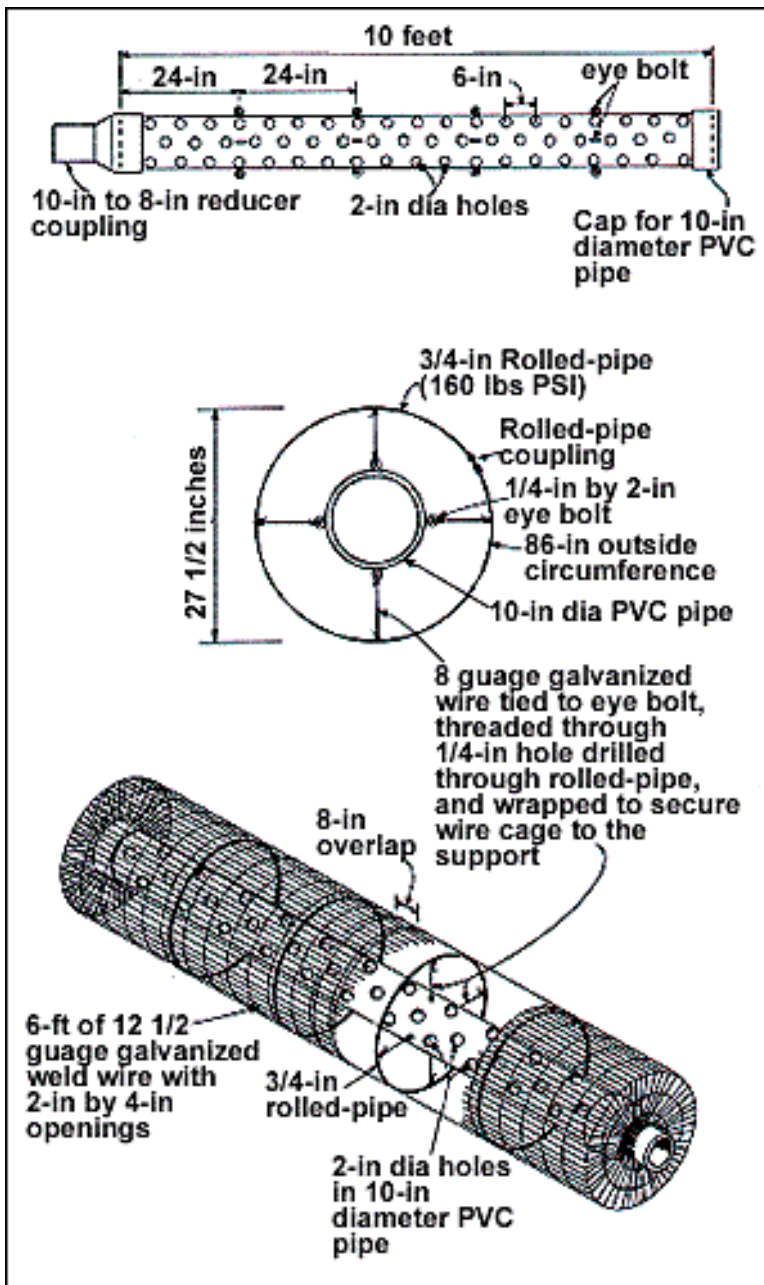

Figure 28. The Clemson Beaver Pond Leveler can easily be constructed of common building materials and installed the same day. (Redrawn from Wood et al. 1994, p. 3-4)

The Clemson Beaver Pond Leveler can be constructed of common building materials that can be obtained at local building and plumbing supply stores for about \$350 (Figure 28). Two people can construct a Leveler in 2 to 3 hours and install the device at the site within 2 hours. Clemson University has made a video on construction and installation of this leveler, which can be purchased from Clemson University Communications Center. The title is "Beaver Pond Leveler: One Solution." The address is: Clemson University Communications Center, 83 Poole Agricultural Center, Clemson, South Carolina 29634-5607.

In such cases, water control devices designed for use in areas where beavers are active can effectively give landowners control of water levels in spite of beaver activity. However, when using water control devices to solve beaver problems, fish passage should be considered.

Culverts constrict water flow and provide good locations for beavers to create impoundments with minimal effort. Beavers will enter culverts and often plug the inside with sticks, rocks, and mud. This creates a difficult problem, that is, keeping the culverts free-flowing. To prevent beavers from entering a culvert, a screen mesh or grill can be placed on the upstream end of the culvert. Beavers will use the mesh or grill as a framework for building a dam and block water flow. The advantage of these devices is that it is easier to remove mud and sticks from outside the culvert than from the inside; however, meshes and grills still require cleaning and maintenance (Buech 1985).

There are many different designs for culvert meshes and grills. Prices for these devices range from a few dollars to several thousand. There are also numerous devices to reduce road damage from the activities of beavers. One such device, the Clemson Beaver Pond Leveler, has been used in the southern States since 1987, and has proven successful (Figures 26 and 27) (Wood et al. 1994). This low cost, low maintenance solution is being used by the Minnesota Department of Natural Resources. To date it has stood up well under the icy conditions of the North.

Geotextiles

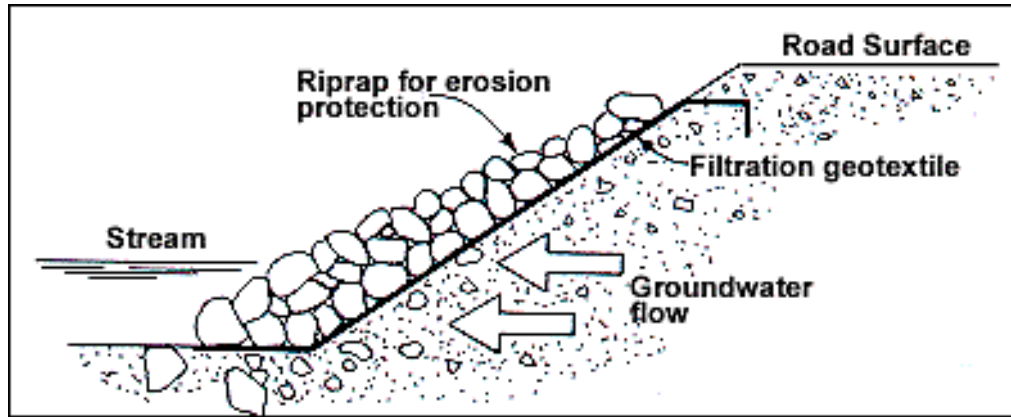

Figure 29. Geotextile material used with riprap allows water movement while preventing movement of soil particles. (Redrawn with permission from Figure 1, Amoco Fabrics and Fibers Company 1994a, p. 1)

A geotextile is a synthetic permeable textile material used with soil, rock, or any other geotechnical engineering related material. Geotextiles, also called geosynthetics, are generally associated with high-standard all-season roads, but can be used in low-standard logging roads.

Geotextiles extend the service life of roads, increase their load-carrying capacity, and reduce the incidence of ruts. These benefits are accomplished by separating aggregate structural layers from subgrade soil while allowing the passage of water (see description on Separation).

Geotextiles should be considered for use on any section of road requiring an aggregate (rock) layer for surfacing. Geotextiles can reduce the amount of aggregate required, thus reducing the cost of the road, as well as providing the benefits described in the previous paragraph.

For temporary road construction in environmentally sensitive areas, a biodegradable woven jute geotextile has been developed. This fabric will totally biodegrade after one to two seasons, eliminating the need to remove a synthetic geotextile from under the roadbed. It is economical for use on roads that will be decommissioned after use (Moran 1997).

There are many uses for geotextiles. The geotextile manufacturer can provide help in selecting the correct material for your specific situation. Rather than describe the many potential conditions under which they may be used, the principles governing their use are described in this section. These principles then can be considered in solving your particular drainage problem.

For example, in an erosion control application, rock or other riprap material may be placed over a geotextile along a streambank as shown in Figure 29. The role of the total system is to prevent erosion of soil materials along the channel. The geotextile performs the specific function of filtration, allowing water in the soil to pass through the fabric while retaining the soil particles.

There are a number of classifications for geotextile functions ranging in number from as few as four to several dozen. This document covers four that are closely associated with low standard roads: separation, filtration, reinforcement, and transmission. Not all functions are provided by each type of geotextile, so check before you buy.

Separation

The separation function refers to the separation of two dissimilar soils. The primary function of the geotextile is to prevent intermixing of the two soils throughout the life of the structure.

Geotextiles are commonly used for separation when used beneath road-way pavement sections. Although you will not be constructing pavement sections, you may want to use some aggregate over certain sections of the road, in which case the principles described here still apply. Roadway pavements are basically structures for taking the high contact pressures from the vehicle tires and reducing that pressure through the depth of the pavement to a level that can be supported by the underlying soil. Pressure is dissipated down through the various layers of materials within the pavement.

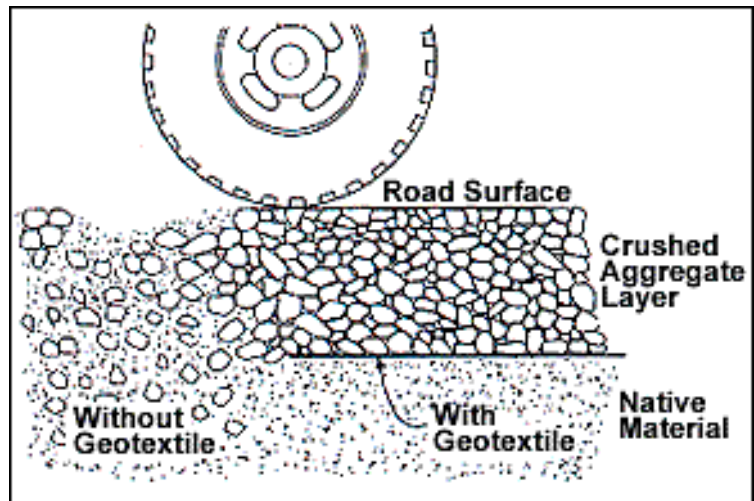

Figure 30. Geotextile material provides separation, which preserves the integrity and extends the life of the road surface layer. (Redrawn with permission from Amoco Fabrics and Fibers Company 1994b)

Over time, vehicle load pressure causes subgrade soils to migrate into the aggregate base of the pavement section. Contamination of the aggregate base by the subgrade results in the reduction of the effective base thickness to less than originally designed. This concept is illustrated in Figure 30. Reduction of the base thickness results in a decrease in the load-carrying capacity of the aggregate base and a reduction in the pavement life. Geotextiles prevent the subgrade materials from migrating into the aggregate base, thus increasing pavement life.

Filtration

Filtration is one of the functions most widely performed by geotextiles. The filtration function has two concurrent objectives: to retain the particles of the filtered soil, while permitting water to pass through the plane of the geotextile from the filtered soil. These two parallel roles are the key to filtration design (Figure 29).

In both the filtration and separation functions, water is permitted to pass through the geotextile. Occasionally, some confusion arises between the separation and filtration functions in this regard. A distinction may be drawn between the two with respect to the quantity of water involved and the degree to which it influences geotextile selection.

In the filtration function, the volume of water moving through the fabric is a key design element specifically addressed in the design and selection of the geotextile. It must be able to convey a certain quantity of water across the plane of the fabric through-out its design life to prevent the buildup of water pressure.

This is typically not the case with a geotextile used for separation. While water may pass in either direction across the plane of the geotextile, it is not typically an element of design as the quantities of water are relatively small, even in those cases of high groundwater and saturated subgrades.

Reinforcement

In the reinforcement function, the geotextile is subjected to a sustained tensile force or load. Soil and rock materials are noted for their ability to withstand compressive forces and their relative low capacity for sustained tensile forces. In much the same way that tensile forces are taken up by steel in a reinforced concrete beam, the geotextile supports tensile forces that cannot be carried by the soil in a soil-geotextile system.

As shown in Figure 31 in a geotextile reinforced levee constructed over soft soils, the geotextile layers are placed across potential rotational failure planes to carry the tensile forces that cannot be carried by an unreinforced soil mass.

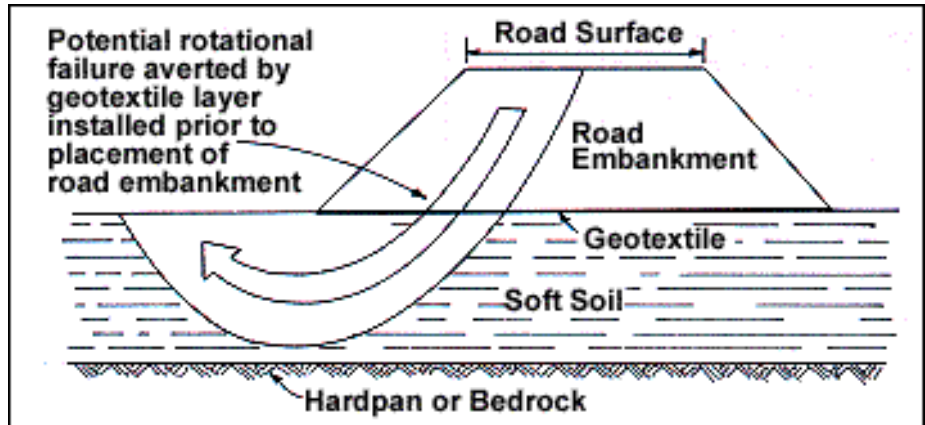

Figure 31. Geotextile material under the roadbed reinforces soft soil and preserves the road embankment. (Redrawn with permission from Figure 8, Amoco Fabrics and Fibers Company 1994a, p. 5)

Transmission

In the transmission function, liquids or gases are carried (or transmitted) within the plane of the geotextile itself. This is distinctly different from the filtration function which involves flow across the plane of the geotextile. This function is often associated with geotextile composites, particularly those that incorporate a drainage net or a permeable core bonded on one or both sides by a geotextile as shown in Figure 32.

Fluid enters the composite through the geotextile and is carried in the channels of the core to a desired location in the application. As shown in Figure 32, a geotextile-drainage core composite can provide drainage adjacent to the face of a retaining wall.

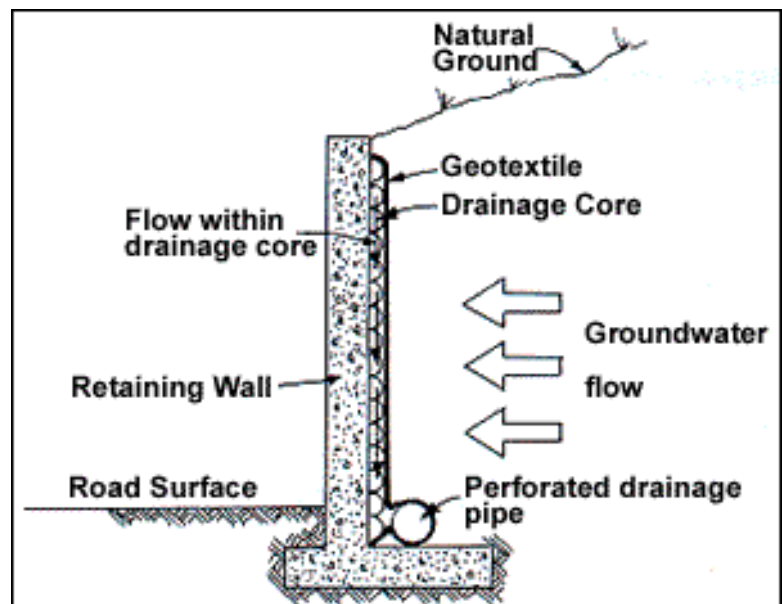

Figure 32. Composite geotextile material allows water flow within the plane of the material, rather than across it, such as behind a retaining wall. (Redrawn with permission from Figure 10, Amoco Fabrics and Fibers Company 1994a, p. 6)

Return to "A Landowner's Guide to Building Forest Access Roads" [Table of Contents](#)

References

- Amoco Fabrics and Fibers Company. 1994a. Geosynthetic functions. Technical note 1. Atlanta, GA; 7 p.
- Amoco Fabrics and Fibers Company. 1994b. Woven geotextiles. In: Geotextile reference manual. Atlanta, GA; [pages unnumbered].
- Buech, Richard R. 1985. Beaver in water impoundments: Understanding a problem of water level management. In: Knightor, M. Dean, ed., Proceedings, Water Impoundments for Wildlife: A Habitat Management Workshop; 1982 Aug. 31-Sept. 2; Bemidji, MN. General Technical Report NC-100. St. Paul, MN: USDA Forest Service, North Central Forest Experiment Station; 95-105.
- Darrach, Alfred G.; Sauerwein, William J.; Hally, Clyde E. 1981. Building water pollution control into small private forest and ranch land roads. R6-S&PF-006-1980. Portland, OR: USDA Forest Service and Soil Conservation Service; [pages unnumbered].
- D'Eon, R. G.; Lapointe, R.; Boswick, N.; Davies, J. C.; Maclean, B.; Watt, W.R.; Wilson, R. G. 1995. The beaver handbook: a guide to understanding and coping with beaver activity. FG-006. Timmins, ON: Ontario Ministry of Natural Resources, Northeast Science and Technology; 76 p.
- Evans, W. A.; Johnston, B. 1980. Fish migration and fish passage: A practical guide to solving fish passage problems. EM-7100-12. Washington, DC: USDA Forest Service; 163 p.
- Furniss, M. J.; Roelofs, T. D.; Yee, C. S. 1991. Chapter 8, Road construction and maintenance. In: Meehan, W. R., ed. Influences of forest and rangeland management on salmonid fishes and their habitats. American Fisheries Society Special Publication 19:297-323.
- Hartung, Robert E.; Kress, James M. 1977. Woodlands of the Northeast erosion and sediment control guides. Broomall, PA: USDA Soil Conservation Service, Northeast Technical Service Center, and Upper Darby [now Radnor], PA: USDA Forest Service, Northeastern Area State and Private Forestry; 25 p.
- Haussman, Richard F.; Pruett, Emerson W. 1978. Permanent logging roads for better woodlot management. NA-FR-18. Broomall [now Radnor], PA: USDA Forest Service, Northeastern Area State and Private Forestry; 43 p.
- Helvey, David J.; Kochenderfer, James N. 1988. Culvert sizes needed for small drainage areas in the central Appalachians. Northern Journal of Applied Forestry; 5:123-127.
- Kochenderfer, James N. 1970. Erosion control on logging roads in the Appalachians. Research Paper NE-158. Radnor, PA: Northeastern Forest Experiment Station, USDA Forest Service; 28 p.
- Michigan Department of Natural Resources. 1994. Water quality management practices on forest land. Lansing, MI: Division of Forestry; 77 p.
- Minnesota Department of Natural Resources. 1995. Protecting water quality and wetlands in forest management: best management practices in Minnesota. St. Paul, MN: Division of Forestry; 140 p.
- Moran, Bob; Belton Industries, Inc. [Letter to Richard Wiest]. 1997 October 20. 1 leaf. Located at: USDA Forest Service, St. Paul, MN.

- West Virginia Department of Agriculture. [No date]. Clean streams handbook for forest landowners: keeping mud out of the streams. Charleston, WV: Forestry Division, Education Subcommittee of the Forest Water Quality Voluntary Compliance Committee; 37 p.
- Wisconsin Department of Natural Resources. 1995. Wisconsin's forestry best management practices for water quality. FR093. Madison, WI; 76 p.
- Wood, Gene W.; Woodward, Larry A. 1992. The Clemson Beaver Pond Leveler. Proceedings, Annual Conference Southeast Association Fish and Wildlife Agencies 46:179-187. (Clemson, SC: Clemson University, Department of Aquaculture, Fisheries and Wildlife.)
- Wood, Gene W.; Woodward, Larry A.; Yarrow, Gregg. 1994. The Clemson Beaver Pond Leveler. Aquaculture Fisheries Wildlife Leaflet 1. Clemson, SC: Cooperative Extension Service, Clemson University; 4 p.
- Yee, Carlton S.; Roelofs, Terry D. 1980. Influence of forest and rangeland management on anadromous fish habitat in western North America: Planning forest roads to protect salmonid habitat. General Technical Report PNW-109. Portland, OR: USDA Forest Service; 26 p.

Return to "A Landowner's Guide to Building Forest Access Roads" [Table of Contents](#)

Glossary

abney: a handheld level, an instrument for measuring slopes or heights.

angle of repose: the maximum slope or angle at which a material such as soil or loose rock remains stable.

back slope: the shaped transition area between the road surface and the undisturbed ground on the uphill side of a road.

bank stability: the ability of stream banks to withstand the erosive forces of water. Bank stability increases in the presence of deeply rooted plants.

berm: a low earth ledge constructed at the side of a road to divert the direction of flowing water.

buffer strip (also leave strip or buffer): strip of vegetation left intact along a stream or lake during and after logging.

channel: a waterway that contains moving water either periodically or continuously. A channel has a definite bed and banks that confine the water.

clinometer: a hand level, an instrument for measuring slopes or heights.

corduroy: logs placed over a wet area to reinforce the natural root mat for the purpose of minimizing the risk of settlement or foundation failure.

culvert: buried pipe or structure that allows stream flow or road drainage to pass under a road. Culverts are often round but can be other shapes as well.

cut and fill: construction of a road on undulating ground that is partly excavated and partly filled.

fill slope: deliberate placing of excavated material elsewhere, and dumping material to create roadbeds.

gabion: a woven wire basket filled with stones of a size that will not pass through the openings in the basket. Individual baskets are tied together to form retaining walls and erosion resistant surfaces.

geotextile: any permeable textile material used with soil, rock or any other geotechnical engineering related material, as an integral part of a man-made product, structure or system, usually related to the passage of water.

groundwater: that part of the subsurface water that is in the zone of saturation, including underground streams.

height of instrument: the elevation difference from viewing lens to the ground.

nonpoint-source pollution: pollution from sources that are not specific, such as areas of timber harvesting, surface mining, and construction.

peat: unconsolidated material consisting of organic matter accumulated under conditions of excessive moisture.

pool: portion of a stream with reduced current velocity, often with deeper water than surrounding areas and with a smoother surface.

riprap: layer of large, durable materials (usually rocks) used to protect a stream bank or lake shore from erosion; may also refer to the materials used.

runoff: the part of precipitation and snowmelt that reaches streams by flowing over the ground.

sediment: fragments of rock, soil, and organic material transported and deposited in bed by water, wind, or other natural phenomena. The term can refer to any size of particles but is often used to indicate only fragments smaller than 6 mm.

sediment pond: a hole created to divert sediment laden water, creating enough residence time to allow the solid material in suspension to drop out, before it is diverted back into a body of water.

sedimentation: deposition of material suspended in water or air, usually when the velocity of the transporting medium drops below the level at which the material can be supported.

sidecast: road construction material that is not used for fill and is pushed to or placed on the down-slope side of the road. Such material may travel long distances down slope before coming to rest. To so move such material.

silt curtain: filter fabric weighted at the bottom and attached to a flotation device at the top. A silt curtain is used to isolate an active construction area within a lake or wetland and prevent silt-laden water from migrating out of the construction zone.

sinkhole: a natural cavity, a hole worn by water through a rock along a joint or fracture, commonly found in Karst (limestone) topography.

spur: often a short, dead-end road that leads to a log landing, usually built to a lower standard than the road it adjoins.

stick: a homemade measuring device of a fixed length used in the stick method of curve layout.

streambank: the part of a stream channel, when seen in cross-section, that restricts the sideways movement of water at normal flows. It represents a distinct break in slope from the streambed.

tagline: a line of ribbon tied to branches of trees or shrubs at eye level. It designates the center line of a proposed road.

tensile force: amount of effort to tear a specific material.

trash rack: a screen of logs or a large metal grate that is placed in front of the inlet end of a culvert to keep large woody debris from entering. A trash rack can become a source of blockage.

turnout: a widened space in a road to allow vehicles to pass one another.

water bar: a ditch and hump across a trail or road tied into the uphill side for the purpose of carrying water runoff into the vegetation, duff, ditch, or dispersion area so it does not gain the volume and velocity which causes soil movement and erosion.

water table: irregular surface of contact between the zone of saturation and the zone of aeration.

wetland: land transitional between terrestrial and aquatic systems where the water table is usually at or near the surface or where shallow water covers the land. A wetland has these three attributes: (1) a predominance of hydric soils (soils that result from wet conditions); (2) inundation or saturation by surface water or ground water at a frequency and duration sufficient to support hydrophytic vegetation (plants adapted to wet conditions); and (3) under normal circumstances, a prevalence of hydrophytic vegetation.

Return to "A Landowner's Guide to Building Forest Access Roads" [Table of Contents](#)

Conversion Chart

(exact factors in parentheses)

When you know...	To find...	Multiply by...
feet	meters	0.03 (0.3048)
inches	centimeters	2.5 (2.54)
millimeters	inches	0.04 (0.03972)
square feet	square meters	0.09
tons	tonnes	0.9
yards	meters	0.9 (0.9144)

Return to "A Landowner's Guide to Building Forest Access Roads" [Table of Contents](#)

Grade Meter

Making the grade meter

1. Remove the page containing the grade meter from this guide.
2. Cut our grade meter along dotted line.
3. Fold over at dashed line.
4. Cut plywood or board to size of paper below fold.
5. Put glue over the entire back side of paper and attach paper to board.
6. Spray with clear varnish or other waterproofing.
7. Put tack or nail at top center point and attach 15-inch string with nut or bolt on other end. Make sure string swings around nail.

Using the grade meter

1. Sight across top edge to person or object at your eye level. Keep the meter vertical so string hangs straight.
2. When the top edge is lined up, hold string against front and read scale of meter for grade (slope) of road or hill.
3. This meter give a rough measure of grade. Fore more exact measurement use an Abney level or clinometer

(Grade meter redrawn from West Virginia Department of Agriculture, no date, pl. 37)

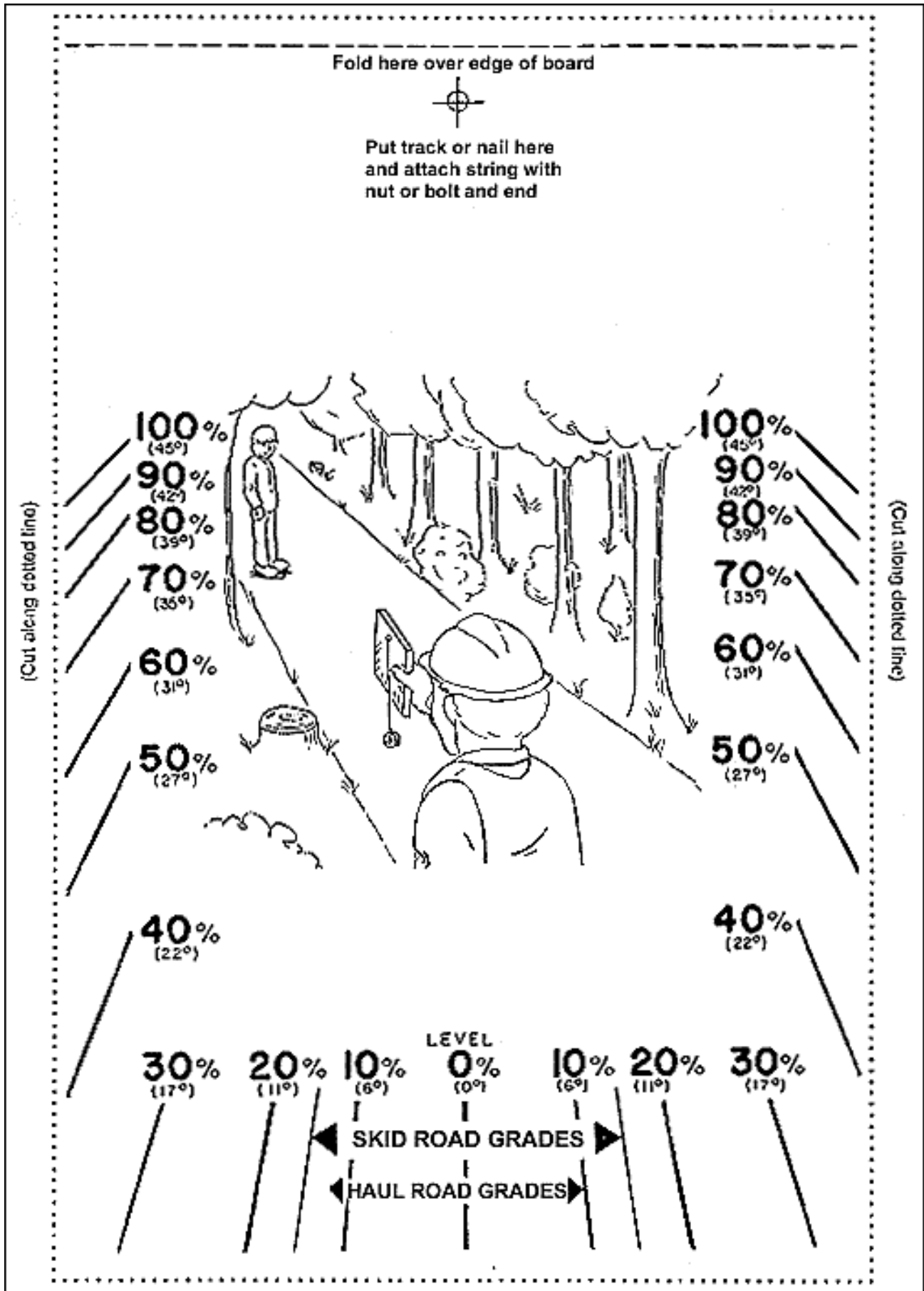

Return to "A Landowner's Guide to Building Forest Access Roads" [Table of Contents](#)